

772/773/773-II

Milliamp Process Clamp Meter

Instruction Sheet

Introduction

The hand-held, battery-operated Fluke 772/773/773-II Milliamp Process Clamp Meters (the Meter or Product) can be used in troubleshooting transmitters, valves, PLC and DCS I/O. Unlike conventional clamp meters, the Meter features a remote jaw that is connected to the main body via extension cable.

Features

- In-circuit measurement of 0 mA to 24 mA dc and up to 99.9 mA dc using a remotely connected clamp via extension cable
- 0 mA to 24 mA dc sourcing and simulating
- 0 V to 10 V dc sourcing (773/773-II)
- Loop power supply 24 V dc output
- 0 V to 30 V dc measurement (773/773-II)
- Scaled mA output (773/773-II)
- Simultaneous mA measurement via detachable clamp and mA sourcing (773/773-II)
- 250 Ω HART resistor for mA source
- Electronic zero
- Percentage span (0 % to 100 %)
- Hold
- Auto power off (battery saver)
- Display backlight
- Measurement spotlight LED

PN 3351049

February 2009 Rev. 2, 6/23

© 2009-2023 Fluke Corporation. All rights reserved.

All product names are trademarks of their respective companies. Specifications are subject to change without notice.

The Meter comes with:

- Four AA alkaline batteries (installed)
- Soft carrying case
- TL75 test leads
- AC 72 detachable clip
- TL 940 mini hook test leads
- Instruction sheet

Contacting Fluke

Fluke Corporation operates worldwide. For local contact information, go to our website: www.fluke.com

To register your product, view, print, or download the latest manual or manual supplement, go to our website.

+1-425-446-5500

fluke-info@fluke.com

To register your product, visit <http://register.fluke.com>.

To view, print, or download the latest manual supplement, visit <http://us.fluke.com/user/support/manuals>.

Safety Information and Symbols

A **Warning** identifies conditions and procedures that are dangerous to the user. A **Caution** identifies conditions and procedures that can cause damage to the Product or the equipment under test.

Warning











To prevent possible electrical shock, fire, or personal injury:

- **Carefully read all instructions.**
- **Do not alter the Product and use only as specified, or the protection supplied by the Product can be compromised.**
- **Read all safety information before you use the Product.**
- **Do not use in CAT III or CAT IV environments without the protective cap installed on test probe. The protective cap decreases the exposed probe metal to <4 mm. This decreases the possibility of arc flash from short circuits.**

- **Comply with local and national safety codes. Use personal protective equipment (approved rubber gloves, face protection, and flame-resistant clothes) to prevent shock and arc blast injury where hazardous live conductors are exposed.**
- **Do not touch voltages >30 V ac rms, 42 V ac peak, or 60 V dc.**
- **Remove the batteries if the Product is not used for an extended period of time, or if stored in temperatures above 50 °C. If the batteries are not removed, battery leakage may result.**
- **The battery door must be closed and locked before you operate the Product.**
- **Replace the batteries when the low battery indicator shows to prevent incorrect measurements.**
- **Do not apply more than the rated voltage, between the terminals or between each terminal and earth ground.**
- **Measure a known voltage first to make sure that the Product operates correctly.**
- **Use the Clamp only on insulated conductors. Use caution around bare conductors or bus bars. To prevent electrical shock, do not touch the conductor.**
- **Do not use test leads if they are damaged. Examine the test leads for damaged insulation, exposed metal, or if the wear indicator shows. Check test lead continuity.**
- **Hold the Product behind the tactile barrier.**
- **Keep fingers behind the finger guards on the probes.**
- **Remove all probes, test leads, and accessories before the battery door is opened.**
- **Remove all probes, test leads, and accessories that are not necessary for the measurement.**
- **Do not exceed the Measurement Category (CAT) rating of the lowest rated individual component of a Product, probe, or accessory.**
- **Do not use the Product if it operates incorrectly.**
- **Disable the Product if it is damaged.**
- **Do not make connections on hazardous live conductors in damp or wet environments.**

Table 1 explains the symbols that are used on the Meter or in this Instruction Sheet.

Table 1. Symbols

Symbol	Explanation
	Consult user documentation.
	WARNING. RISK OF DANGER.
	WARNING. HAZARDOUS VOLTAGE. Risk of electric shock.
	Power on/off
	Do not apply around or remove from uninsulated hazardous live conductors without taking additional protective measures.
	Double Insulated
	Avoid strong magnetic fields.
	Earth Ground
	Battery
	Conforms to European Union directives.
CAT II	Measurement Category II is applicable to test and measuring circuits connected directly to utilization points (socket outlets and similar points) of the low-voltage MAINS installation.
CAT III	Measurement Category III is applicable to test and measuring circuits connected to the distribution part of the building's low-voltage MAINS installation.
CAT IV	Measurement Category IV is applicable to test and measuring circuits connected at the source of the building's low-voltage MAINS installation.
	This product complies with the WEEE Directive and its marking requirements. The affixed label indicates that you must not discard this electrical/electronic product in domestic household waste. Do not dispose of this product as unsorted municipal waste. For information about take-back and recycling programs available in your country, see the Fluke website.

Getting Acquainted with the Meter

Figures 1-4 explain the Meter's features, buttons, input/output jacks, and display.

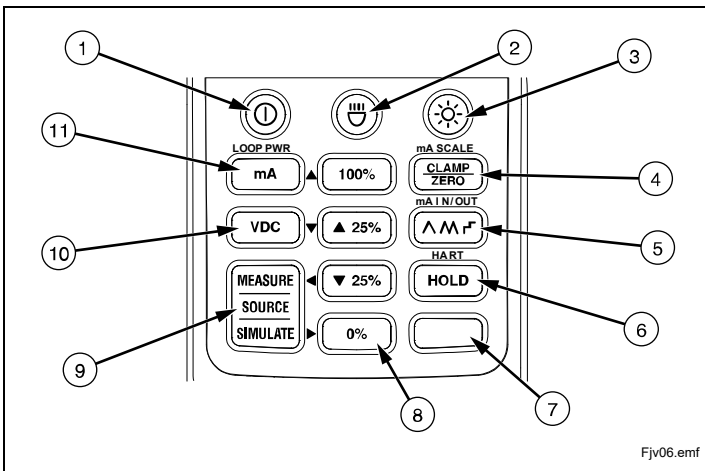

Fjv06.emf

Number	Description
①	Turn on and off the Meter
②	Measurement spotlight LED button
③	Turns the display backlight on and off
④	Switches the Meter to Clamp Measure mode. Zeros the clamp reading in Clamp mode. The Clamp modes includes clamp measure, mA scale output, and mA IN/OUT. Press <input type="button" value=""/> first to change to mA scale (773/773-II).
⑤	Cycles through source output ramping and 25 % stepping: (Λ) Slow repeating 0 % - 100 % - 0 % ramp (M) Fast repeating 0 % - 100 % - 0 % ramp (r) Repeating 0 % - 100 % - 0 % ramp in 25 % steps Press <input type="button" value=""/> first to activate mA IN/OUT (773/773-II).
⑥	Captures and holds the current reading. Pressing <input type="button" value=""/> first activates the 250 Ω HART resistor.
⑦	<input type="button" value=""/> activates features listed above some buttons
⑧	0 %-100 %- sets voltage or mA sourcing output. Press <input type="button" value=""/> first to activate ▲, ▼, ◀, and ▶ to adjust the source output. Long press <input type="button" value="0%"/> or <input type="button" value="100%"/> to set span range point.
⑨	Measure, Source, Simulate button
⑩	DC Volts selection (773/773-II)
⑪	mA selection. Press <input type="button" value=""/> first to activate Loop Power function.

Figure 1. Buttons

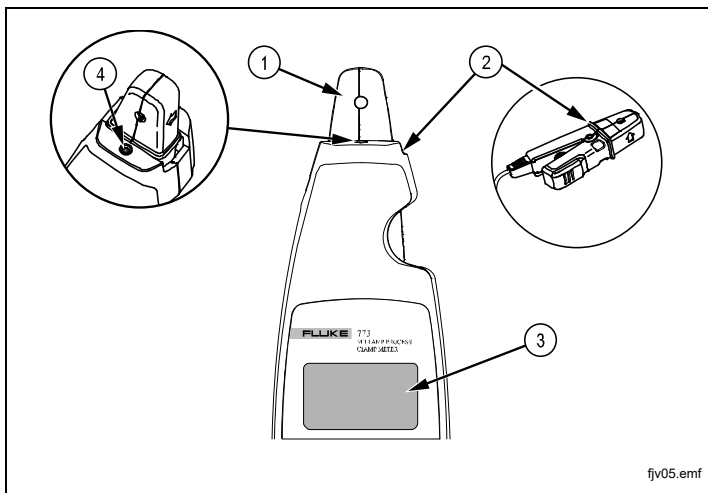

fjv05.emf

Number	Description
①	Detachable clamp
②	Tactile Barrier docked and un-docked. Refer to <i>Safety Information and Symbols</i> .
③	Display
④	Measurement spotlight LED

Figure 2. The Milliamp Process Clamp Meter

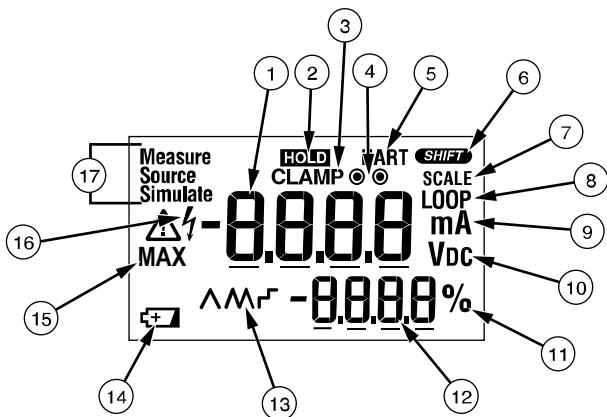

Fjv07.emf

Number	Description
①	Main display values
②	HOLD is activated
③	Clamp is active
④	Test lead jack indicator. Test lead connection is required.
⑤	HART 250 Ω resistor is engaged
⑥	Shift is active
⑦	Reading is scaled
⑧	Loop Power is active
⑨	Milliamps
⑩	Volts dc
⑪	Percentage
⑫	Secondary display
⑬	Ramping is engaged
⑭	Low battery symbol
⑮	Maximum voltage warning
⑯	High voltage is present
⑰	Measure, Source, or Simulate is active

Figure 3. Display (773/773-II shown)

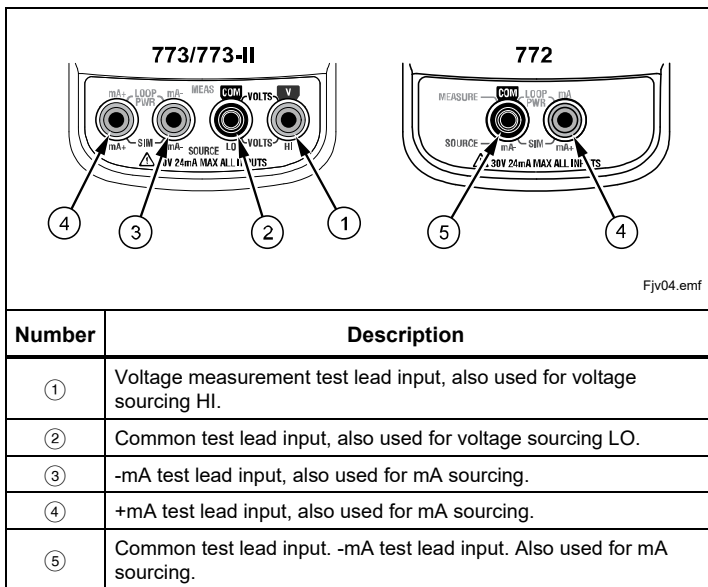

Figure 4. Input/Output Jacks

Features

The following sections give more detail about the Meter's features.

Percentage Span

The Source and Simulate Percentage Span feature displays the span for 4 to 20 mA loops. Use , , , and to adjust the source or simulated current (772) or dc voltage and current (773/773-II).

20 mA	100 %	8 mA	25 %
16 mA	75 %	4 mA	0 %
12 mA	50 %	0 mA	-25 %



Zero Adjust



Before taking measurements with the clamp, push to zero the display by removing the offset. Make sure the clamp jaws are closed and no current is flowing through them before zeroing.

Backlight

Press to turn the backlight on and off. The backlight automatically turns off after 2 minutes.

User Options

Several user options can be activated at Meter power up. Hold  when powering on the Meter. While holding down , toggle on/off each option by repeatedly pressing the following keys:

-  toggle on/off backlight auto off. Display shows **bLit on** or **oFF**.
-  toggle on/off spotlight auto off. Display shows **SLit on** or **oFF**.
-  toggle on/off auto power off. Display shows **PoFF on** or **oFF**.

When all key are released, the software version appears and the Meter enters Clamp Measure mode.

Measurement Spotlight LED



The Measurement Spotlight LED helps to quickly find mA signal wires. Press  to activate it. To extend battery life, the light automatically turns off after 2 minutes.

Display HOLD

Warning

To prevent possible electrical shock, fire, or personal injury:



- **Be aware of the measurement being taken when using Display HOLD. When Display HOLD is activated, the display will not change when different currents are applied.**
- **Do not use the HOLD function to measure unknown potentials. When HOLD is turned on, the display does not change when a different potential is measured.**

Press  to activate Display Hold mode. The display shows **HOLD** and the display freezes. To exit and return to normal operation, press  a second time. When in Auto Ramping mode,  stops ramping.

Auto Ramping the Output

Auto ramping can continuously apply a varying output from the mA source to a device while your hands remain free to test the response.

When  is pressed, the Meter produces a repeating 0 % - 100 % - 0 % ramp in a choice of three ramp waveforms:

-  0 % - 100 % - 0 % 40-second smooth ramp
-  0 % - 100 % - 0 % 30-second smooth ramp
-  0 % - 100 % - 0 % 25 % step ramp, 10 seconds each step.

To exit ramping, press any button.

Probe Holder

The Meter is equipped with a probe holder that can either hold a test probe or can be used to attach the Fluke ToolPak. See Figure 5.

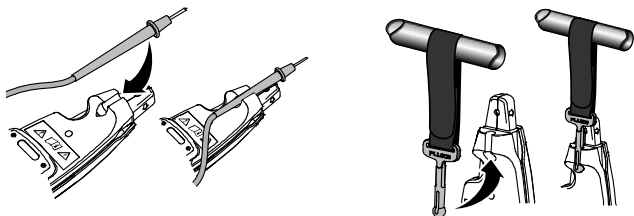

Fjv08.emf

Figure 5. The Probe Holder

Taking Measurements

⚠ ⚠ Warning

To prevent possible electric shock, fire, or personal injury, do not use the clamp on non-insulated conductors.

Measurements can be taken with the clamp in the docked position, remotely using the 1 m cable, or via test leads. For accurate measurements:

- Always zero the Meter prior to taking measurements with the clamp.
- To reduce magnetic influences, zero the Meter as close to the measurement in the same position or jaw direction that is used for the measurements as possible.
- Make sure the clamp is free of contamination.

To use the clamp for measurements:

1. Press **CLAMP ZERO** to enter Clamp Measure mode and to zero the Meter. Clamp mode includes clamp measure, mA scale output, and mA IN/OUT. If necessary, press **□** to change to mA scale.
2. Clamp the jaw around the conductor under test. The Meter displays the measured conductor current. See Figure 6.
 - A positive reading indicates current flowing in the direction of the arrow on the clamp.
 - A negative reading indicates current flowing in the opposite direction of the arrow.
 - Do not clamp more than one wire.

The small secondary display shows the reading in mA percentage of span.

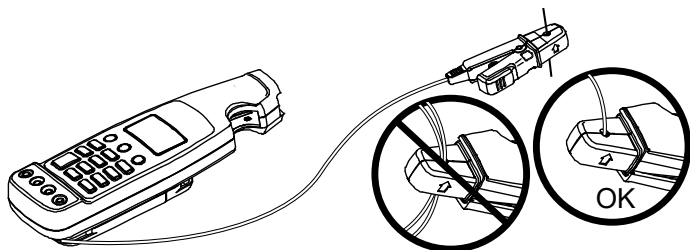

fjv03.emf

Figure 6. Taking Measurements with the Clamp

To use the test leads for measurements:

1. Insert the test leads into the proper input jacks. See Figure 7.
2. Press the correct button for the measurement.
3. Apply the test leads.
4. Observe the reading on the main display. In mA mode, the secondary display shows the reading in percentage of span.

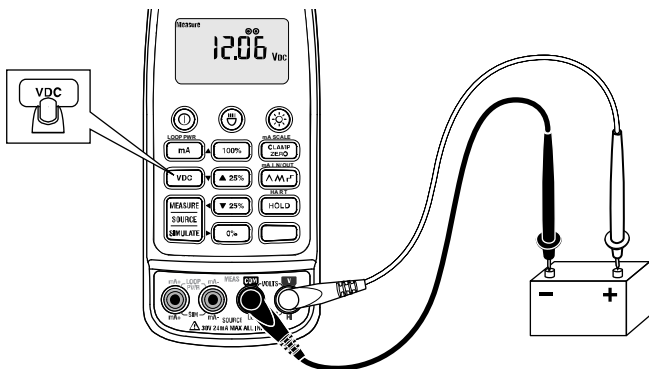

fjv09.emf

Figure 7. Taking Measurements with the Test Leads

Current and Voltage Output Functions

Both Meters provide steady, stepped, and ramped current output for testing 0-24 mA current loops. Additionally, the 773/773-II provides voltage output to 10 V. To access these functions, press  as necessary.

- Choose Source mode to supply current or voltage.
- Choose Simulate mode to regulate current in an externally powered current loop.
- Choose Loop Supply mode to power an external device and measure mA loop current.

Sourcing mA

Use mA Source mode whenever it is necessary to source current into a passive circuit such as a current loop with no loop supply. Source mode depletes the battery faster than Simulate mode.

To enter Source mode for the 772, see Figure 4:

1. Insert the test leads into the -mA and +mA jacks.
2. Press **mA**.
3. Press **MEASURE SOURCE SIMULATE** until **Source** appears on the display.

To enter mA Source mode for the 773/773-II, see Figure 8:

1. Insert the test leads into the desired input jacks.
2. Press **mA**.
3. Press **MEASURE SOURCE SIMULATE** until **Source** appears on the display.

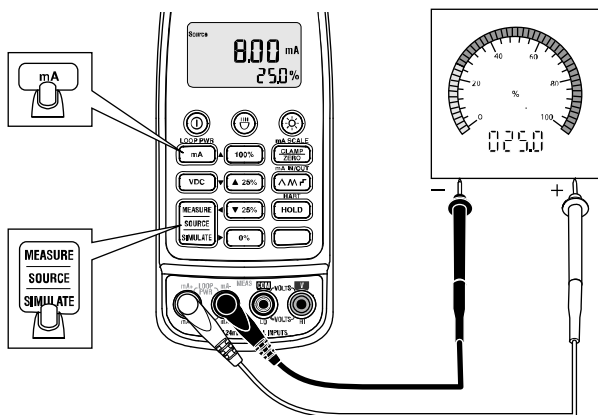

Fjv10.emf

Figure 8. Sourcing mA Output

Simulating mA Output

In Simulate mode, the Meter simulates a current loop transmitter. To enter Simulate mode, see Figure 9:

1. Insert the test leads into the +mA and -mA input jacks.
2. Press **mA**.
3. Press **MEASURE SOURCE SIMULATE** until **Simulate** appears on the display.

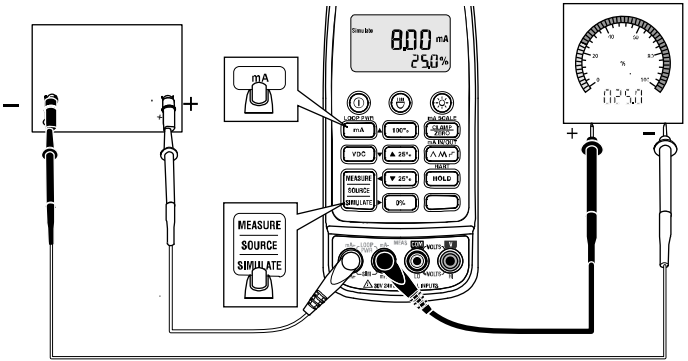

Fjv11.emf

Figure 9. Simulating mA Output

Loop Supply

In Loop Supply mode, the Meter powers a transmitter while measuring the mA signal. To enter Loop Supply mode, see Figure 10:

1. Insert the test leads into the **LOOP PWR** jacks. See Figure 10.
2. Press .
3. Press

The Meter is now in Loop Supply mode.

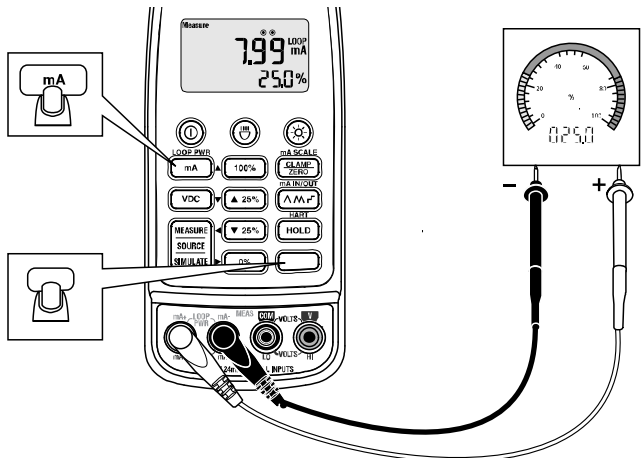

Fjv13.emf

Figure 10. Using Loop Supply Mode

Maintenance

⚠️⚠️ Warning

To prevent possible electric shock, fire, or personal injury:

- Remove the input signals before you clean the Product.
- Repairs or servicing not covered in this manual should be performed only by qualified personnel.
- Replace all batteries with fresh batteries of the same manufacturer and type to prevent battery leakage.

Cleaning the Meter

Clean the instrument case with a damp cloth and mild detergent.

Battery Replacement

⚠️⚠️ Warning

To avoid false readings, that could lead to possible electric shock or personal injury, replace the batteries as soon as the low battery indicator (⚡) appears.

To replace the batteries, see Figure 11:

1. Turn the Meter off.
2. Use a flat head screwdriver to loosen the battery compartment door screw, and remove the door from the case bottom.
3. Remove the batteries.
4. Replace the batteries with four new AA batteries.
5. Reattach the battery compartment door to the case bottom and tighten the screw.

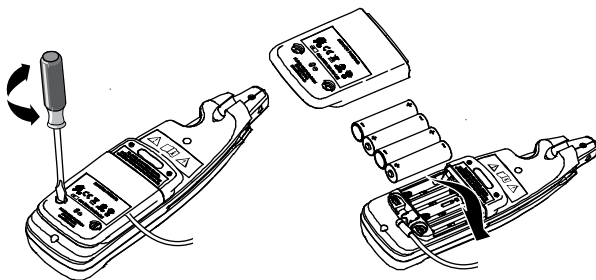

Figure 11. Changing the Batteries

Product Disposal

Dispose of the Product in a professional and environmentally sound manner:

1. Delete personal data on the Product before disposal.
2. Remove batteries that are not integrated into the electrical system before disposal and dispose of batteries separately.
3. If this Product has an integral battery, put the entire Product in the electrical waste.

Specifications

Electrical Specifications

DC Current Measurement

With Jaw

Ranges	0 mA to 20.99 mA; 21 mA to 100 mA
Resolution.....	0.01 mA, 0.1 mA
Accuracy.....	0.2 % + 5 counts, 1 % + 5 counts

In Circuit

Range.....	0 mA to 24 mA
Resolution.....	0.01 mA
Accuracy.....	0.2 % + 2 counts

Current Source

Range.....	0 mA to 24 mA
Resolution.....	0.01 mA
Accuracy.....	0.2 % + 2 counts
mA Drive.....	24 mA into 1000 Ω

Current Simulate

Range.....	0 mA to 24 mA
Resolution.....	0.01 mA
Accuracy.....	0.2 % + 2 counts
Maximum Voltage.....	50 V

DC Voltage Measurement (773/773-II)

Range.....	0 V to 30 V
Resolution.....	0.01 V
Accuracy.....	0.2 % + 2 counts

DC voltage source (773/773-II)

Range.....	0 V to 10 V
Resolution.....	0.01 V
Accuracy.....	0.2 % + 2 counts
mA Drive.....	2 mA max all conditions

mA IN/OUT (773/773-II)

Sourcing range	0 mA to 24 mA
----------------------	---------------

Sourcing resolution.....	0.01 mA
Sourcing accuracy.....	0.2 % + 2 counts
Measurement range.....	0 mA to 24 mA
Measurement resolution.....	0.01 mA
Measurement accuracy.....	1 % FS
Scaled mA current output to mA current input from the Jaw (773/773-II)	
Range.....	0 mA to 24 mA
Resolution.....	0.01 mA
Accuracy.....	1 % FS
Response speed.....	2x/second
DC Loop Power.....	24 V
Influence of Earth's Field.....	<0.20 mA
Batteries.....	4 1.5 V, Alkaline, IEC LR6
Working hours.....	12 hours @ 12 mA sourced into 500 Ω

Mechanical Specifications

Size (H X W X L).....	43.7 mm x 70 mm x 246.2 mm
Weight.....	410 g

Environmental Specifications

Operating Temperature.....	-10 °C to 50 °C
Storage Temperature.....	-25 °C to 60 °C
Operating Humidity.....	<90 % RH @ <30 °C <75 % RH @ 30 °C to 50 °C
Operating Altitude.....	0 m to 2000 m
IP Rating.....	IP 40
Temperature Coefficients.....	0.1 (/ °C X Specified accuracy for Temperature <18 °C or >28 °C)
Safety.....	IEC 61010-1, Pollution degree 2 IEC 61010-2-032: O, Measuring circuits without a measurement category.

Electromagnetic Compatibility (EMC)

International	IEC 61326-1: Portable Electromagnetic Environment IEC 61326-2-2 CISPR 11: Group 1, Class A
---------------------	---

Group 1: Equipment has intentionally generated and/or uses conductively-coupled radio frequency energy that is necessary for the internal function of the equipment itself.

Class A: Equipment is suitable for use in all establishments other than domestic and those directly connected to a low voltage power supply network that supplies buildings used for domestic purposes. There may be potential difficulties in ensuring electromagnetic compatibility in other environments due to conducted and radiated disturbances.

Caution: This equipment is not intended for use in residential environments and may not provide adequate protection to radio reception in such environments.

Emissions that exceed the levels required by CISPR 11 can occur when the equipment is connected to a test object.

The equipment may not meet the immunity requirements of this standard when test leads and/or test probes are connected.

For current measurement with jaw, add 1 mA to specification for EMC fields from 1 V/m to 3 V/m.

Korea (KCC).....	Class A Equipment (Industrial Broadcasting & Communication Equipment)
------------------	---

Class A: Equipment meets requirements for industrial electromagnetic wave equipment and the seller or user should take notice of it. This equipment is intended for use in business environments and not to be used in homes.

USA (FCC).....	47 CFR 15 subpart B. This product is considered an exempt device per clause 15.103.
----------------	---

Miscellaneous Specifications

Power Requirements.....	Four AA batteries, Alkaline, IEC LR6
Automatic Time-out (Power).....	15 minutes \pm 1 minute
Automatic Time-out (Backlight).....	2 minutes \pm 10 seconds
Automatic Time-out (Measurement Spotlight).....	2 minutes \pm 10 seconds

User Replaceable Parts

Table 2 lists all user replaceable parts.

Table 2. Replaceable Parts

Part or Model Number	Description	Quantity
376756	AA Batteries, 1.5 V	4
3369914	Absorber	1
3350978	Battery Door	1
948609	Fastener	2
3351060	Soft Carrying Case	1
download from www.fluke.com	Instruction Sheet	1
download from www.fluke.com	Calibration Manual	1
1616705	TL940 Mini Hook with Test Lead	1 Set
855742	TL75- Test Leads	1 Set
4101772	AC175 Alligator Clips	1 Set
3031302	Hook and Loop Strip	1
669967	TPAK, Strap 17 inches	1
3375746	Hanger	1
Replacement clamp and cable assembly are available but require re-calibration. See the 772/773/773-II <i>Calibration Manual</i> for part numbers and procedures.		

LIMITED WARRANTY & LIMITATION OF LIABILITY

The Fluke 772/773 will be free from defects in material and workmanship for 3 years (one year for cable and clamp) from the date of purchase. The 773-II will be free from defects in material and workmanship for 5 years (one year for cable and clamp) from the date of purchase. This warranty does not cover fuses, disposable batteries or damage from accident, neglect, misuse or abnormal conditions of operation or handling. Resellers are not authorized to extend any other warranty on Fluke's behalf. To obtain service during the warranty period, send your defective product to the nearest Fluke Authorized Service Center with a description of the problem.

THIS WARRANTY IS YOUR ONLY REMEDY. NO OTHER WARRANTIES, SUCH AS FITNESS FOR A PARTICULAR PURPOSE, ARE EXPRESSED OR IMPLIED. FLUKE IS NOT LIABLE FOR ANY SPECIAL, INDIRECT, INCIDENTAL OR CONSEQUENTIAL DAMAGES OR LOSSES, ARISING FROM ANY CAUSE OR THEORY. Since some states or countries do not allow the exclusion or limitation of an implied warranty or of incidental or consequential damages, this limitation of liability may not apply to you.

Fluke Corporation
P.O. Box 9090
Everett, WA 98206-9090
U.S.A.

Fluke Europe B.V.
P.O. Box 1186
5602 BD Eindhoven
The Netherlands

制造商：安徽世福仪器有限公司
生产地址：安徽省芜湖市鸠江经济
开发区龙腾路 66 号
电话：0553-5610888

