

FLUKE®

725Ex

Multifunction Process Calibrator

Users Manual

January 2005 Rev. 3, 5/18

© 2005-2018 Fluke Corporation, All rights reserved. Specifications are subject to change without notice.
All product names are trademarks of their respective companies.

LIMITED WARRANTY AND LIMITATION OF LIABILITY

Each Fluke product is warranted to be free from defects in material and workmanship under normal use and service. The warranty period is three years and begins on the date of shipment. Parts, product repairs, and services are warranted for 90 days. This warranty extends only to the original buyer or end-user customer of a Fluke authorized reseller, and does not apply to fuses, disposable batteries, or to any product which, in Fluke's opinion, has been misused, altered, neglected, contaminated, or damaged by accident or abnormal conditions of operation or handling. Fluke warrants that software will operate substantially in accordance with its functional specifications for 90 days and that it has been properly recorded on non-defective media. Fluke does not warrant that software will be error free or operate without interruption.

Fluke authorized resellers shall extend this warranty on new and unused products to end-user customers only but have no authority to extend a greater or different warranty on behalf of Fluke. Warranty support is available only if product is purchased through a Fluke authorized sales outlet or Buyer has paid the applicable international price. Fluke reserves the right to invoice Buyer for importation costs of repair/replacement parts when product purchased in one country is submitted for repair in another country.

Fluke's warranty obligation is limited, at Fluke's option, to refund of the purchase price, free of charge repair, or replacement of a defective product which is returned to a Fluke authorized service center within the warranty period.

To obtain warranty service, contact your nearest Fluke authorized service center to obtain return authorization information, then send the product to that service center, with a description of the difficulty, postage and insurance prepaid (FOB Destination). Fluke assumes no risk for damage in transit. Following warranty repair, the product will be returned to Buyer, transportation prepaid (FOB Destination). If Fluke determines that failure was caused by neglect, misuse, contamination, alteration, accident, or abnormal condition of operation or handling, including overvoltage failures caused by use outside the product's specified rating, or normal wear and tear of mechanical components, Fluke will provide an estimate of repair costs and obtain authorization before commencing the work. Following repair, the product will be returned to the Buyer transportation prepaid and the Buyer will be billed for the repair and return transportation charges (FOB Shipping Point).

THIS WARRANTY IS BUYER'S SOLE AND EXCLUSIVE REMEDY AND IS IN LIEU OF ALL OTHER WARRANTIES, EXPRESS OR IMPLIED, INCLUDING BUT NOT LIMITED TO ANY IMPLIED WARRANTY OF MERCHANTABILITY OR FITNESS FOR A PARTICULAR PURPOSE. FLUKE SHALL NOT BE LIABLE FOR ANY SPECIAL, INDIRECT, INCIDENTAL, OR CONSEQUENTIAL DAMAGES OR LOSSES, INCLUDING LOSS OF DATA, ARISING FROM ANY CAUSE OR THEORY.

Since some countries or states do not allow limitation of the term of an implied warranty, or exclusion or limitation of incidental or consequential damages, the limitations and exclusions of this warranty may not apply to every buyer. If any provision of this Warranty is held invalid or unenforceable by a court or other decision-maker of competent jurisdiction, such holding will not affect the validity or enforceability of any other provision.

Fluke Corporation
P.O. Box 9090
Everett, WA 98206-9090
U.S.A.

Fluke Europe B.V.
P.O. Box 1186
5602 BD Eindhoven
The Netherlands

Table of Contents

Title	Page
Introduction	1
Contact Fluke	1
Standard Equipment.....	3
Safety Information	3
Ex Hazardous Areas	3
Faults and Damage	9
Faults and Damage	9
Safety Regulations	9
Certification Information.....	10
Getting Acquainted with the Calibrator	10
Input and Output Terminals	10
Keys	12
Display.....	15
Getting Started	16
Shut Down Mode.....	16
Contrast Adjustment.....	18
Using Measure Mode	19
Measuring Electrical Parameters (Upper Display).....	19

Current Measurement with Loop Power.....	19
Measuring Electrical Parameters (Lower Display)	21
Measuring Temperature.....	22
Using Thermocouples	22
Using Resistance-Temperature Detectors (RTDs).....	25
Measuring Pressure.....	28
Zeroing with Absolute Pressure Modules.....	29
Using Source Mode	31
Sourcing 4 to 20 mA.....	31
Simulating a 4- to 20-mA Transmitter.....	31
Sourcing Other Electrical Parameters	31
Simulating Thermocouples.....	34
Simulating RTDs	34
Source Pressure Mode	37
Setting 0 % and 100 % Output Parameters	39
Stepping and Ramping the Output.....	39
Manually Stepping the mA Output	39
Auto Ramping the Output.....	40
Storing and Recalling Setups.....	40
Calibrating a Transmitter.....	41
Calibrating a Pressure Transmitter	43
Calibrating an I/P Device	45
Switch Test	47
Testing an Output Device	48
Replacing the Batteries.....	49
Approved Batteries	50
Maintenance	50
Cleaning the Calibrator	50

Service Center Calibration or Repair	51
Replacement Parts	51
Accessories	53
Specifications	55
DC Voltage Measurement	55
DC Voltage Source	55
Millivolt Measurement and Source*	55
DC mA Measurement and Source	56
Ohms Measurement	56
Ohms Source	56
Frequency Measurement	56
Frequency Source	57
Temperature, Thermocouples	57
Loop Power Supply	57
RTD Excitation (simulation)	58
Temperature, RTD Ranges, and Accuracies	58
Pressure Measurement	59
General Specifications	59

Multifunction Process Calibrator

Introduction

Warning

Read "Safety Information" before using the Calibrator.

The Fluke 725Ex Multifunction Process Calibrator (hereafter referred to as "the Calibrator") is a handheld, battery-operated instrument that measures and sources electrical and physical parameters. For a summary of source and measurement functions, see Table 1.

In addition to the functions in Table 1, the Calibrator has the following features and functions:

- A split-screen display - The upper display allows the user to measure volts, current, and pressure only. The lower display allows the user to measure and source volts, current, pressure, resistance temperature detectors, thermocouples, frequency, and ohms.
- Calibrates a transmitter using the split-screen.
- A thermocouple (TC) input/output terminal and internal isothermal block with automatic reference junction temperature compensation.
- Stores and recalls setups.

- Manual stepping and automatic stepping and ramping.

Contact Fluke

To contact Fluke, call one of the following telephone numbers:

- Technical Support USA: 1-800-44-FLUKE (1-800-443-5853)
- Calibration/Repair USA: 1-888-99-FLUKE (1-888-993-5853)
- Canada: 1-800-36-FLUKE (1-800-363-5853)
- Europe: +31 402-675-200
- Japan: +81-3-6714-3114
- Singapore: +65-6799-5566
- China: +86-400-921-0835
- Anywhere in the world: +1-425-446-5500

Or, visit Fluke's website at www.fluke.com.

To register your product, visit <http://register.fluke.com>.

To view, print, or download the latest manual supplement, visit <http://us.fluke.com/usen/support/manuals>

Table 1. Summary of Source and Measure Functions

Function	Measure	Source
dc V	0 V dc to 30 V dc	0 V dc to 10 V dc
dc mA	0 to 24 mA dc	0 to 24 mA
Frequency	1 CPM to 10 kHz	1 CPM to 10 kHz
Resistance	0 Ω to 3200 Ω	15 Ω to 3200 Ω
Thermocouple	Types E, J, K, T, B, R, S, L, U, N, mV, XK, BP	
RTD (Resistance- Temperature Detector)	Ni120 Pt100 Ω (385) Pt100 Ω (3926) Pt100 Ω (3916) Pt200 Ω (385) Pt500 Ω (385) Pt1000 Ω (385)	
Pressure	Fluke 750PEx series modules ranging from 10 inH ₂ O to 3000 psi	Fluke 750PEx series modules ranging from 10 inH ₂ O to 3000 psi using an external pressure source (hand pump).
Other functions	Loop-Power Supply, Step, Ramp, Memory, Dual Display	

Standard Equipment

The items listed below and shown in Figure 1 are included with the Calibrator. If the Calibrator is damaged or something is missing, contact the place of purchase immediately. To order replacement parts, see Replacement Parts in Table 9.

- TL75 test leads with caps (one set)
- Alligator clips (one set)
- Stackable alligator clip test leads (one set)
- *Fluke 725Ex CCD*
- *Fluke 725Ex Safety Information*
- 4 AA Batteries (installed)
- Hex Key, 5/64 in., short arm

Safety Information

A **Warning** statement identifies conditions and actions that pose a hazard(s) to the user. A **Caution** statement identifies conditions and actions that may damage the Calibrator or the equipment under test.

Symbols used on the Calibrator and in this manual, are explained in Table 2.

Ex Hazardous Areas

The Model 725Ex Calibrator has been designed for use in Ex Hazardous Areas. These are areas where potentially flammable or explosive vapors may occur. These areas are referred to as hazardous (classified) locations in the United States (NFPA 70 Article 500), as Hazardous Locations in Canada (CSA C22.1 Section 18), and as Explosive Gas Atmospheres by most of the rest of the world. The Model 725Ex calibrator is designed as intrinsically safe. This means that connecting the 725Ex calibrator to equipment that is used within intrinsically safe circuits will not cause an ignition capable arc as long as the entity parameters are suitably matched.

The Calibrator has two sets of parameters. The V_{max} and I_{max} parameters show the maximum voltage and maximum current that may be connected to the Model 725Ex terminals without compromising the intrinsic safety. The voltage and current will generally come from intrinsic safety barriers that provide power to the field equipment such as transmitters and positioners (I/P devices). These barriers are identified with a maximum open circuit voltage parameter (V_{oc}) and a maximum short circuit current parameter (I_{sc}). The matching criterion requires that V_{oc} of the barrier not exceed 30 V and I_{sc} not exceed 100 mA. The Calibrator will itself be a source of voltage and current. Each set of terminals has a V_{oc} and an I_{sc} rating as shown on the Calibrator CCD. When connecting

terminals to other equipment, the V_{max} and I_{max} ratings on the other equipment must exceed the V_{oc} and I_{sc} ratings for the terminals connected to on the 725Ex calibrator.

In addition to matching voltage and current entity parameters, it is also necessary to verify that capacitance and inductance has not been exceeded. Again, the Calibrator CCD identifies the maximum capacitance (C_a) and maximum inductance (L_a) that is permitted based either on the intrinsic safety barrier ratings or on the Calibrator ratings for the specific terminals used. As an example, the Calibrator CCD explains that the capacitance of each unit connected in the circuit (C_i) plus the capacitance of the cable in the circuit must not exceed the maximum allowed capacitance (C_a). Use a similar approach for inductance in the intrinsically safe circuit.

When connecting the Calibrator into a powered circuit, that is, when the circuit is powered by an intrinsic safety barrier, then the maximum circuit voltage used for the entity parameter evaluation will be the higher of either the Calibrator V_{oc} or of the barrier V_{oc} . The maximum current will be the sum of the Calibrator I_{sc} and the barrier I_{sc} . In this case, the maximum allowed inductance (L_a) will be reduced. This value will have to be determined using the ignition curves found in standards such as CSA C22.2 No. 157 or UL 913.

For additional information about Ex Hazardous Areas, refer to ANSI/ISA-12.01.01-2013 Definitions and

Information Pertaining to Electrical Instruments in Hazardous (Classified) Locations and to ANSI/ISA-RP12.06.01-2003 Recommended Practice for Wiring Methods for Hazardous (Classified) Locations Instrumentation Part 1: Intrinsic Safety.

⚠ Warning

To prevent fire, explosion, or personal injury:

- Use the Calibrator only as described in this User Manual and the Fluke 725Ex CCD (Concept Control Drawing) or the protection provided by the Calibrator may be impaired.
- Inspect the Calibrator before use. Do not use it if it appears damaged.
- Check the test leads for continuity, damaged insulation, or exposed metal. Replace damaged test leads.
- When using probes, keep fingers behind the finger guards on the probes.
- Never apply more than 30.0 V between the input terminals, or between any terminal and earth ground.
- Applying more than 30.0 V to the input terminals invalidates the Calibrator's Ex Approval and may result in permanent damage to the Calibrator so it can no longer be used.
- Use the proper terminals, mode, and range for the measuring or sourcing application.
- To prevent damage to the device under test, be sure the Calibrator is in the correct mode before connecting the test leads.
- Never open the Calibrator case. Opening the case invalidates the Calibrator's Ex Approval.
- Make sure the battery door is closed and latched before entering an Ex hazardous area or using the Calibrator. See "Ex Hazardous Areas".
- Remove the Calibrator from the Ex-hazardous area before opening the battery door. See "Ex Hazardous Areas".
- Remove test leads from the Calibrator before opening the battery door.
- When servicing the Calibrator, use only specified replacement parts. Do not open the Calibrator case. Opening the case invalidates the Calibrator's Ex Approval.
- Do not allow water inside the case.
- Do not operate the Calibrator around explosive dust.
- When using a pressure module, make sure the process pressure line is shut off and depressurized before connecting it or disconnecting it from the pressure module.
- Use four properly installed AA batteries to power the Calibrator.
- Use only the batteries listed in Table 8.

- **Disconnect test leads from the circuit under test before changing to another measure or source function.**
- **When measuring the pressure of toxic or flammable gases, care must be taken to minimize the possibility of leakage. Confirm that all pressure connections are properly sealed.**
- **Do not use in a damp or wet environment.**

⚠ Caution

To avoid possible damage to Calibrator or to equipment under test:

- **Disconnect the power and discharge all high-voltage capacitors before testing resistance or continuity.**
- **Use the proper jacks, function, and range for the measurement or sourcing application.**
- **The MEASURE/SOURCE terminals on the Calibrator are sensitive to Electro-static discharge (ESD) at levels above ± 2 kV. The Calibrator can experience temporary loss of measurement or source functionality. This can require you to restore product function, or cause permanent damage to the Calibrator. Usually, a disruptive ESD event occurs only when you connect the test leads to the circuits being measured or if you have a large static charge and touch the Calibrator terminals. The most common cause of ESD is a user that carries the Calibrator across a carpet, or other similar triboelectric activity, before they connect to the circuit being measured.**

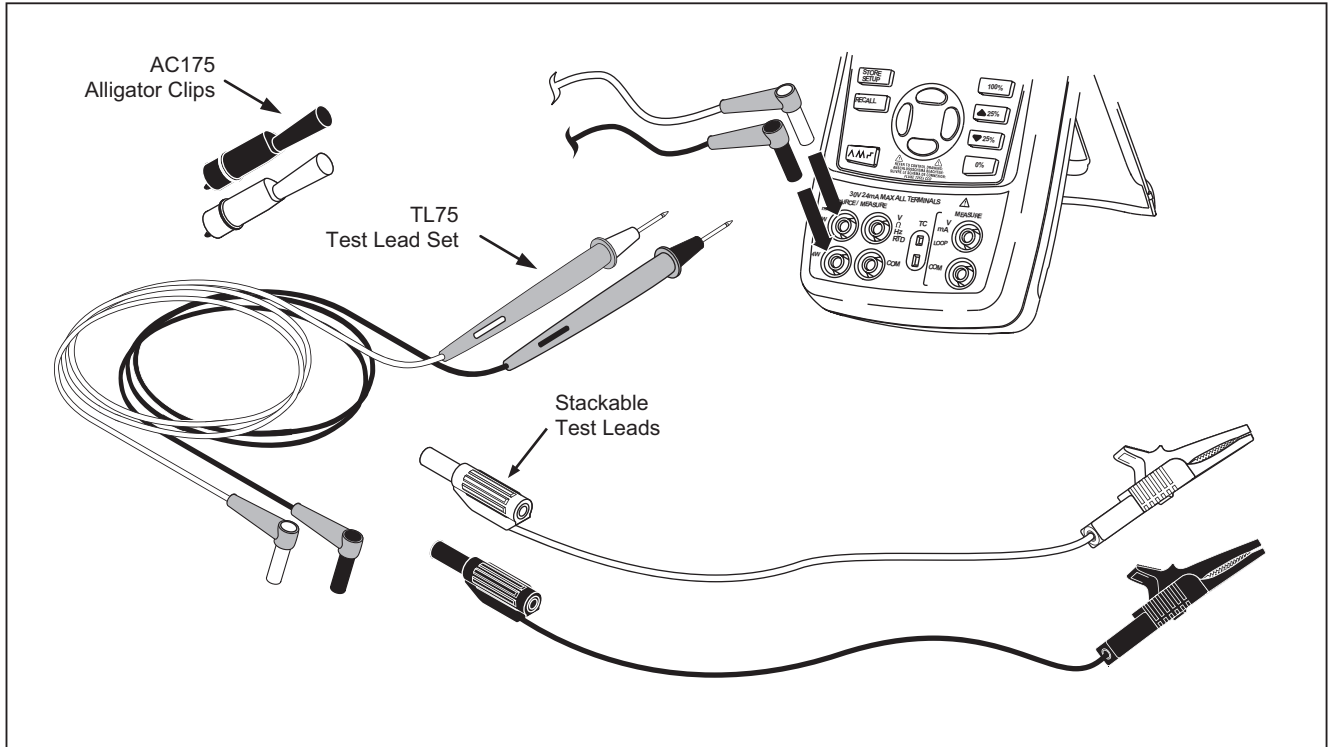













Figure 1. Standard Equipment

aly01f.eps

Table 2. Symbols

Symbol	Meaning	Symbol	Meaning
	WARNING. RISK OF DANGER.		Consult user documentation.
	Power ON/OFF		Double insulated
	Earth ground		Pressure
	Battery		Certified by CSA Group to North American safety standards.
	Direct current		Conforms to relevant Australian Safety and EMC standards.
	Conforms to relevant South Korean EMC Standards.		
	This product complies with the WEEE Directive marking requirements. The affixed label indicates that you must not discard this electrical/electronic product in domestic household waste. Product Category: With reference to the equipment types in the WEEE Directive Annex I, this product is classed as category 9 "Monitoring and Control Instrumentation" product. Do not dispose of this product as unsorted municipal waste.		

Faults and Damage

Applying a voltage greater than 30 V to the input of the Calibrator invalidates its Ex Approval and may impair its safe operation in an Ex-hazardous area. See “Ex Hazardous Areas”.

If there is any reason to suspect that the safe operation of the Calibrator has been affected, it must be immediately withdrawn from use, and precautionary measures must be taken to prevent any further use of the Calibrator in an Ex-hazardous area. See *Ex Hazardous Areas*.

Fully observe all instructions, warnings, and cautions contained in this manual. In case of doubt due to translation and/or printing errors, refer to the original English users manual.

The safety features and integrity of the Calibrator may be compromised by any of the following:

- External damage to the case
- Internal damage to the Calibrator
- Exposure to excessive loads
- Incorrect storage of the Calibrator
- Damage sustained in transit
- Certification markings are illegible
- Functioning errors occur
- Permitted limitations are exceeded

- Functioning errors or obvious measurement inaccuracies occur which prevent further measurement by the Calibrator
- Opening the case

Safety Regulations

The use of the Calibrator meets the requirements of the regulations providing that the user observes and applies the requirements as stated in the regulations and that improper and incorrect use of the Calibrator is avoided.

- Use must be restricted to the specified application parameters.
- Do not open the Calibrator.
- Do not remove or install the batteries within the Ex-hazardous area. See “Ex Hazardous Areas”.
- Do not carry additional batteries within the Ex-hazardous area. See “Ex Hazardous Areas”.
- Use only type tested batteries. The use of any other batteries will invalidate the Ex-certification and present a safety risk.
- Do not use the Calibrator in any circuit where the voltage or transients may exceed 30 V.
- Only use the Calibrator in circuits with compatible entity parameters. When the calibrator is used in an Ex hazardous area, unless the area is known to be safe, do not connect to any circuits that exceed the entity parameters defined on Fluke 725Ex CCD Control Drawing. See *Ex Hazardous Areas*.

Certification Information

-  Class I Div. 1 Groups B, C, and D
Class I Zone 0 AEx/Ex ia IIB 171 °C
- Ta = -10 °C... +55 °C
- Manufactured by Fluke Corporation
6920 Seaway Blvd.
Everett, WA 98203, USA

Getting Acquainted with the Calibrator

Input and Output Terminals

Figure 2 shows the Calibrator input and output terminals.
Table 3 explains their use.

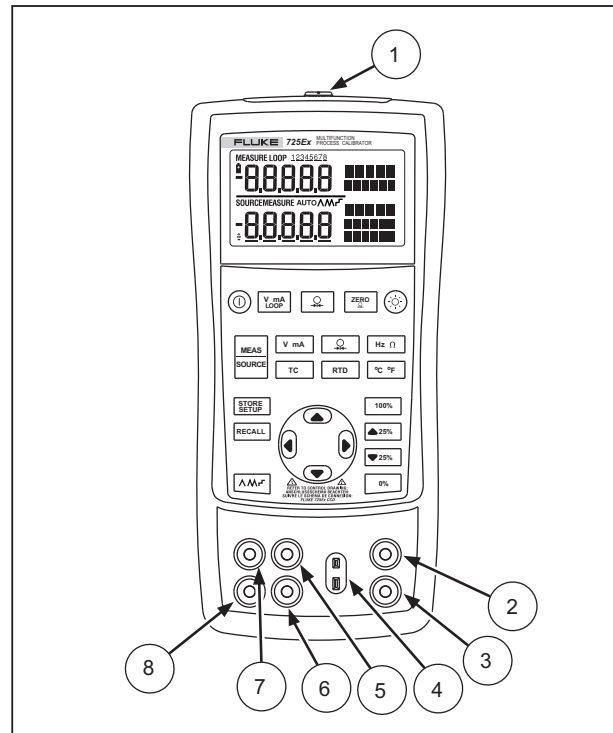

Figure 2. Input/Output Terminals and Connectors

aly05f.eps

Table 3. Input/Output Terminals and Connectors

No	Name	Description
①	Pressure module connector	Connects the Calibrator to a pressure module.
②, ③	MEASURE V, mA terminals	Input terminals for measuring voltage, current, and supplying loop power.
④	TC input/output	Terminal for measuring or simulating thermocouples. This terminal accepts a miniature polarized thermocouple plug with flat, inline blades spaced 7.9 mm (0.312 in) center to center.
⑤, ⑥	SOURCE/ MEASURE V, RTD, Hz, Ω terminals	Terminals for sourcing or measuring voltage, resistance, frequency, and RTDs.
⑦, ⑧	SOURCE/ MEASURE mA terminals, 3W, 4W	Terminals for sourcing and measuring current, and performing 3W and 4W RTD measurements.

Keys

Figure 3 shows the Calibrator keys and Table 4 explains their use.

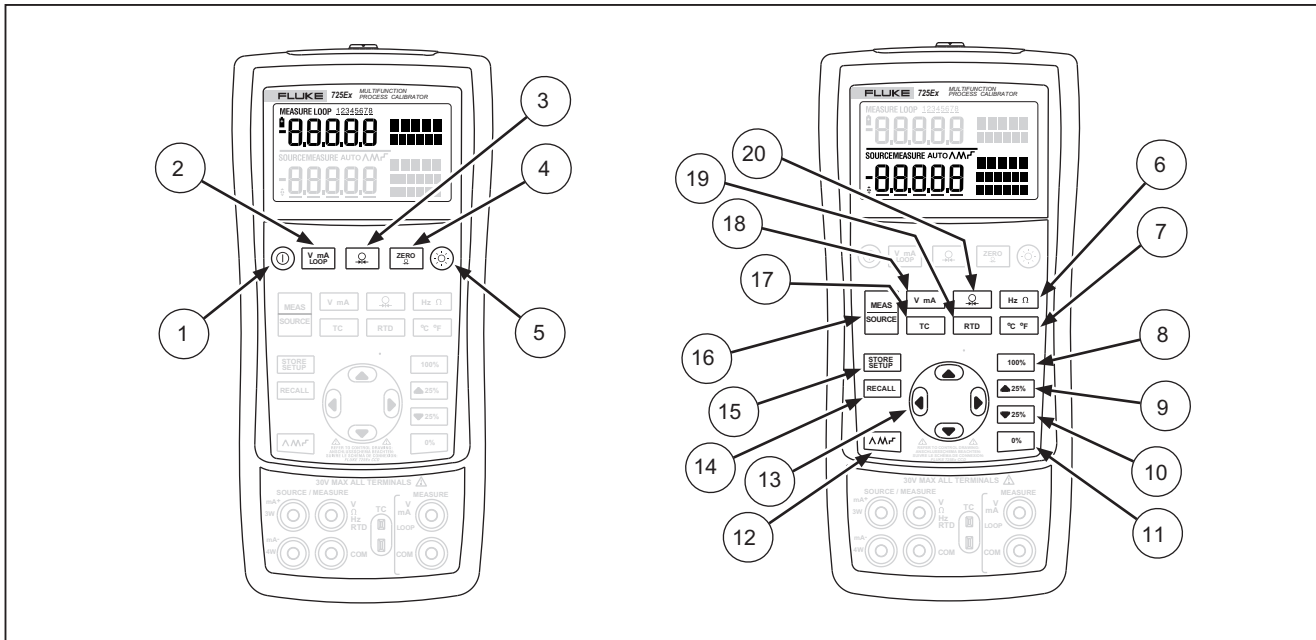

Figure 3. Keys

aly41f.eps

Table 4. Key Functions























No.	Key	Description
①		Turns the power on and off.
②		Selects voltage, mA, or loop power measurement functions in the upper display. Clears the switch test. See "Switch Test".
③		Selects the pressure measurement function in the upper display. Repeated pushes cycle through the different pressure units. Use for pressure switch test. See "Switch Test".
④		Zeros the pressure module reading. This applies to both upper and lower displays.
⑤		Turns backlight on and off.
⑥		Toggles between frequency and ohms measurement and sourcing functions.
⑦		Toggles between Centigrade and Fahrenheit when in TC or RTD functions.
⑧		Recalls a source value from memory corresponding to 100 % of span and sets it as the source value. Press and hold to store the source value as the 100 % value.
⑨		Increments output by 25 % of span.
⑩		Decrements output by 25 % of span.
⑪		Recalls a source value from memory corresponding to 0 % of span and sets it as the source value. Press and hold to store the source value as the 0 % value.
⑫		Cycles through : \wedge Slow repeating 0 % - 100 % - 0 % ramp Λ Fast repeating 0 % - 100 % - 0 % ramp \lrcorner Repeating 0 % - 100 % - 0 % ramp in 25 % steps

Table 4. Key Functions (cont.)

No.	Key	Description
①+⑬		Disables Shut Down Mode
①+⑬		Enables Shut Down Mode
⑬		Increases or decreases the source level. Cycles through the 2-, 3-, and 4-wire selections. Moves through the memory locations of calibrator setups. In Contrast Adjustment mode; up-darkens contrast, down-lightens contrast.
⑭		Retrieves a previous calibrator setup from a memory location.
⑮		Saves the Calibrator setup. Saves Contrast Adjust setup.
⑯		Cycles the Calibrator through MEASURE and SOURCE modes in the lower display.
⑰		Selects the TC (thermocouple) measurement and sourcing function in the lower display. Repeated pushes cycle through the thermocouple types.
⑱		Toggles between voltage, mA sourcing, or mA simulate functions in the lower display.
⑲		Selects RTD (resistance temperature detector) measurement and sourcing function in lower display. Repeated pushes cycle through the RTD types.
⑳		Selects the pressure measurement and sourcing function. Repeated pushes cycle through the different pressure units.

Display

Figure 4 shows the elements of the display.

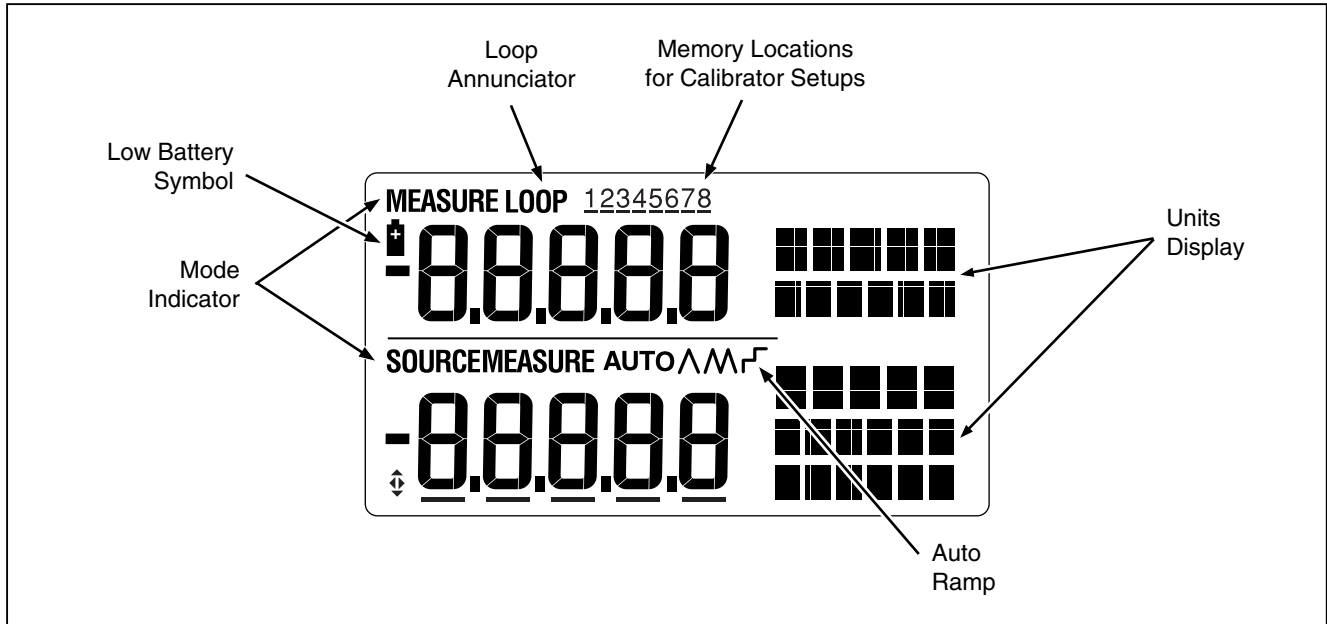





Figure 4. Elements of a Typical Display









sh07f.eps

Getting Started









This section introduces some basic operations of the Calibrator.

Proceed as follows to perform a voltage-to-voltage test:

1. Connect the Calibrator's voltage output to its voltage input as shown in Figure 5.
2. Press  to turn on the Calibrator. Press  to select dc voltage (upper display).
3. If necessary, press  for SOURCE mode (lower display). The Calibrator is still measuring dc voltage; the active measurements are visible in the upper display.
4. Press  to select dc voltage sourcing.

5. Press  and  to select a digit to change. Press  to select 1 V for the output value. Press and hold  to enter 1 V as the 0 % value.
6. Press  to increase the output to 5 V. Press and hold  to enter 5 V as the 100 % value.
7. Press  and  to step between 0 % and 100 % in 25 % step increments.

Shut Down Mode

The calibrator comes with the Shut Down mode enabled for a time duration set to 30 minutes (displayed for about 1 second when the calibrator is initially turned on). When the Shut Down mode is enabled, the calibrator will automatically shut down after the time duration has elapsed from the time the last key was pressed. To disable the Shut Down mode, press  and  simultaneously. To enable the mode, press  and  simultaneously. To adjust the time duration, press  and  simultaneously, then press  and/or  to adjust the time between 1 minute and 30 minutes.

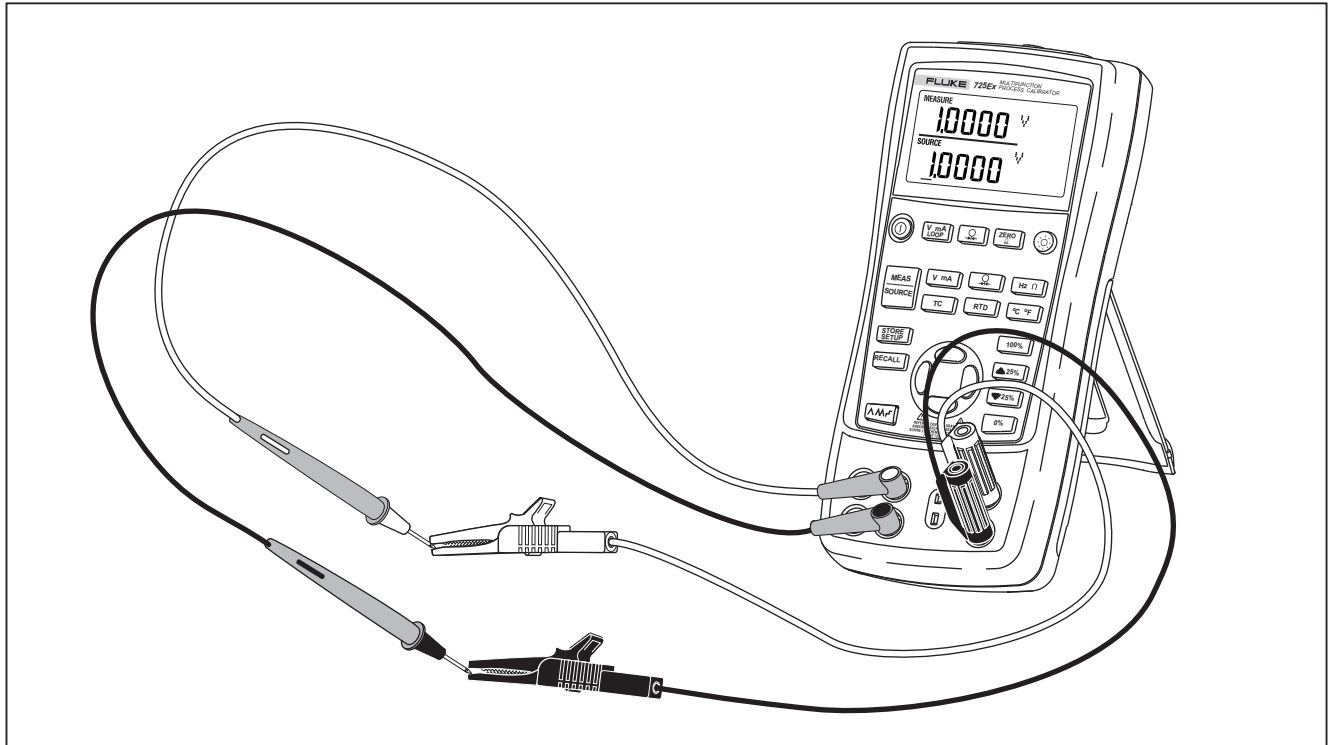







Figure 5. Voltage-to-Voltage Test

aly39f.eps

Contrast Adjustment

To adjust the contrast, proceed as follows:

1. Press  and  until Contst Adjust is displayed as shown in Figure 6.
2. Press and hold  to darken contrast.
3. Press and hold  to lighten contrast.
4. Press  to save the contrast level.

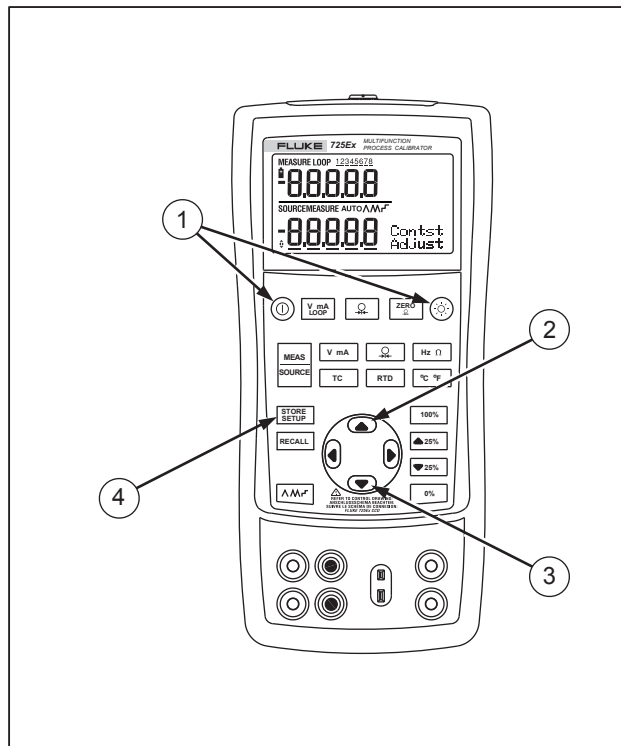

Figure 6. Adjusting the Contrast

sh06f.eps

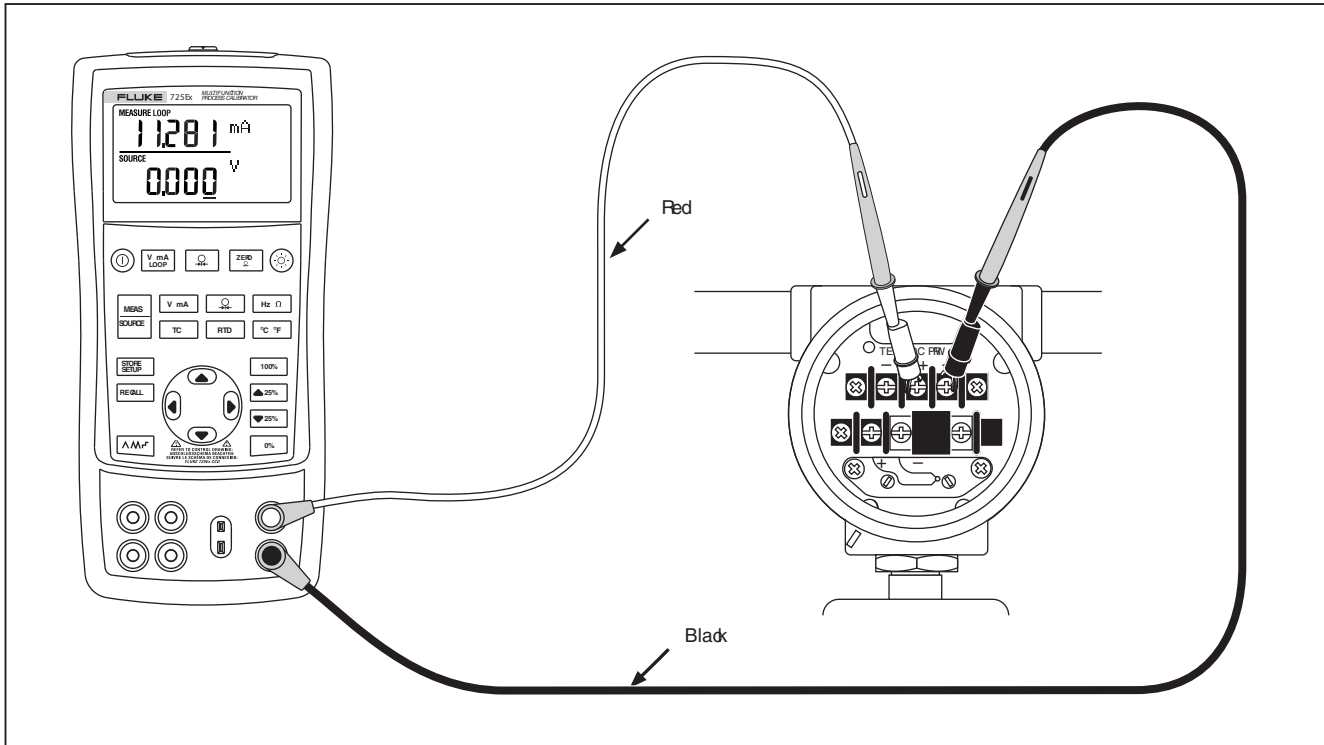

Figure 8. Connections for Supplying Loop Power

aly18f.eps

Measuring Temperature

Using Thermocouples

The Calibrator supports twelve standard thermocouples, including types E, N, J, K, T, B, R, S, L, XK, BP, and U. Table 5 summarizes the ranges and characteristics of the supported thermocouples.

To measure temperature using a thermocouple, proceed as follows:

1. Attach the thermocouple leads to the appropriate TC miniplug, then to the TC input/output as shown in Figure 10.

Caution

One thermocouple pin is wider than the other. To avoid possible damage to Calibrator or to equipment under test do not try to force a miniplug in the wrong polarization.

Note

If the Calibrator and the thermocouple plug are at different temperatures, wait one minute or more for the connector temperature to stabilize after plugging the miniplug into the TC input/output.



2. If necessary, press  for MEASURE mode.
3. Press  for the TC display. Continue pressing this key to select the desired thermocouple type.
If necessary, toggle between °C or °F temperature units by pressing .

Table 5. Thermocouple Types Accepted

Type	Positive Lead Material	Positive Lead (H) Color		Negative Lead Material	Specified Range (°C)
		ANSI*	IEC**		
E	Chromel	Purple	Violet	Constantan	-200 to 950
N	Ni-Cr-Si	Orange	Pink	Ni-Si-Mg	-200 to 1300
J	Iron	White	Black	Constantan	-200 to 1200
K	Chromel	Yellow	Green	Alumel	-200 to 1370
T	Copper	Blue	Brown	Constantan	-200 to 400
B	Platinum (30 % Rhodium)	Gray		Platinum (6 % Rhodium)	600 to 1800
R	Platinum (13 % Rhodium)	Black	Orange	Platinum	-20 to 1750
S	Platinum (10 % Rhodium)	Black	Orange	Platinum	-20 to 1750
L	Iron			Constantan	-200 to 900
U	Copper			Constantan	-200 to 400
XK	90.5 % Ni + 9.5 % Cr	GOST		56 % Cu + 44 % Ni	-200 to 800
		Violet or Black			
BP	95 % W + 5 % Re	Red or Pink		80 % W + 20 % Re	0 to 2500

*American National Standards Institute (ANSI) device negative lead (L) is always red.

**International Electrotechnical Commission (IEC) device negative lead (L) is always white.

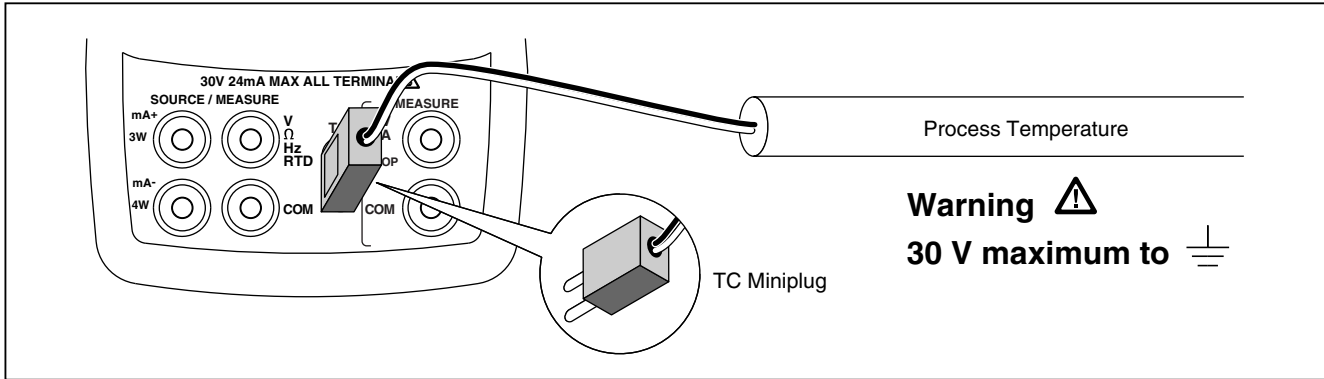

Figure 10. Measuring Temperature with a Thermocouple

aly12f.eps

Using Resistance-Temperature Detectors (RTDs)

The Calibrator accepts RTD types shown in Table 6. RTDs are characterized by their resistance at 0 °C (32 °F), which is called the “ice point” or R_0 . The most common R_0 is 100 Ω . The Calibrator accepts RTD measurement inputs in two-, three-, or four-wire connections, with the three-wire connection the most common. A four-wire configuration provides the highest measurement precision, and two-wire provides the lowest measurement precision.

To measure temperature using an RTD input, proceed as follows:

If necessary, press  for MEASURE mode.





1. Press  for the RTD display. If desired, continue pressing this key to select the desired RTD type.
2. Press  or  to select a 2-, 3-, or 4- wire connection.
3. Attach the RTD to input terminals as shown in Figure 11.
4. If necessary, toggle between °C or °F temperature units by pressing .

Table 6. RTD Types Accepted

RTD Type	Ice Point (R₀)	Material	α	Range (°C)
Pt100 (3926)	100 Ω	Platinum	0.003926 $\Omega/^\circ\text{C}$	-200 to 630
Pt100 (385)	100 Ω	Platinum	0.00385 $\Omega/^\circ\text{C}$	-200 to 800
Ni120 (672)	120 Ω	Nickel	0.00672 $\Omega/^\circ\text{C}$	-80 to 260
Pt200 (385)	200 Ω	Platinum	0.00385 $\Omega/^\circ\text{C}$	-200 to 630
Pt500 (385)	500 Ω	Platinum	0.00385 $\Omega/^\circ\text{C}$	-200 to 630
Pt1000 (385)	1000 Ω	Platinum	0.00385 $\Omega/^\circ\text{C}$	-200 to 630
Pt100 (3916)	100 Ω	Platinum	0.003916 $\Omega/^\circ\text{C}$	-200 to 630
The IEC standard RTD and the most commonly used RTD in U.S. industrial applications is the Pt100 (385), $\alpha = 0.00385 \Omega/^\circ\text{C}$.				

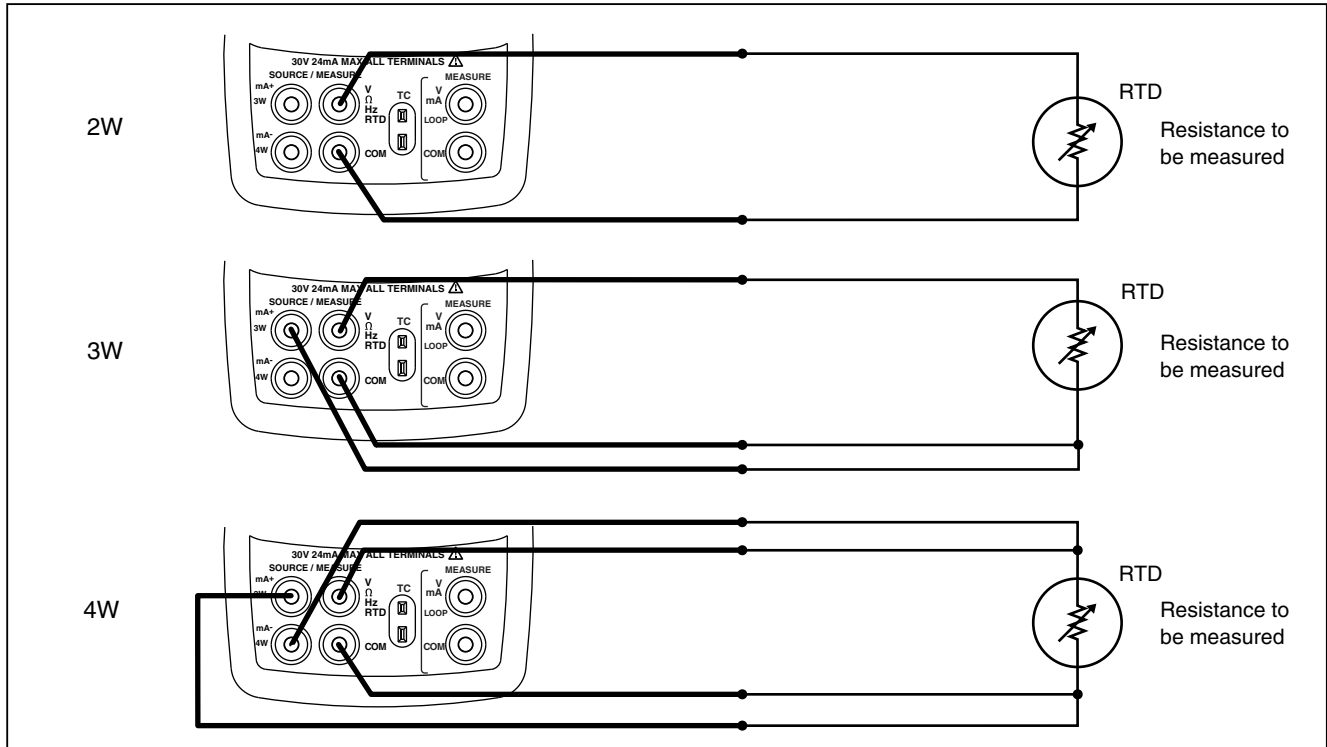

Figure 11. Measuring Temperature with an RTD, Measuring 2-, 3-, and 4-Wire Resistance

aly15f.eps

Measuring Pressure

Many ranges and types of pressure modules are available from Fluke. See “Accessories” near the back of this manual. Before using a pressure module, read its instruction sheet. The modules vary in use, media, and accuracy.

Figure 12 shows the Gage and Differential modules. Differential modules also work in gage mode by leaving the low fitting open to atmosphere.

To measure pressure, attach the appropriate pressure module for the process pressure to be tested

Proceed as follows to measure pressure:

⚠ Warning

To prevent fire, explosion, or personal injury:

- Use only Fluke pressure modules.
- To avoid a violent release of pressure in a pressurized system, shut off the valve and slowly bleed off the pressure before attaching the pressure module to the pressure line.

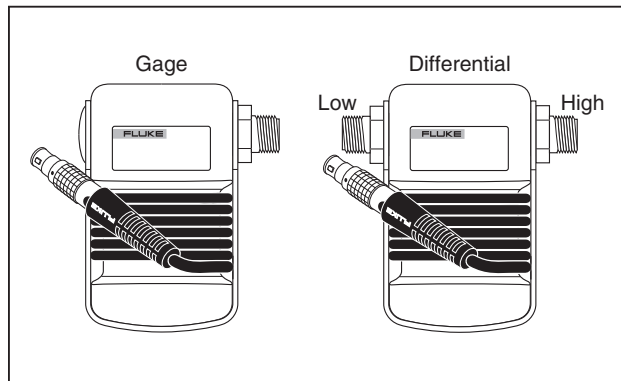





Figure 12. Gage and Differential Pressure Modules

⚠ Caution





- To avoid mechanically damaging the pressure module, never apply more than 10 lb-ft (13.5 Nm) of torque between the pressure module fittings, or between the fittings and the body of the module. Always apply appropriate torque between the pressure module fitting and connecting fittings or adapters.
- To avoid damaging the pressure module from overpressure, never apply pressure above the rated maximum printed on the pressure module.

- **To avoid damaging the pressure module from corrosion, use it only with specified materials. Refer to the printing on the pressure module or the pressure module instruction sheet for the acceptable material compatibility.**
1. Connect a pressure module to the Calibrator as shown in Figure 13. The threads on the pressure modules accept standard ¼ NPT pipe fittings. Use the supplied ¼ NPT to ¼ ISO adapter if necessary.
 2. Press . The Calibrator automatically senses which pressure module is attached and sets its range accordingly.
 3. Zero the pressure module as described in the module's instruction sheet. Modules vary in zeroing procedures depending on module type, but all require pressing .

If desired, continue pressing  to change pressure display units to psi, mmHg, inHg, cmH₂O@4 °C, cmH₂O@20 °C, inH₂O@4 °C, inH₂O@20 °C, inH₂O@60 °F, mbar, bar, kg/cm², or kPa.

Zeroing with Absolute Pressure Modules

To zero, adjust the Calibrator to read a known pressure. This can be barometric pressure, if it is accurately known. An accurate pressure standard can also apply a pressure within range for any absolute pressure module. To adjust the Calibrator reading, proceed as follows:

1. Press , REF Adjust will appear to the right of the pressure reading.
2. Use  to increase or  to decrease the Calibrator reading to equal the reference pressure.
3. Press  again to exit zeroing procedure.

The Calibrator stores and automatically reuses the zero offset correction for one absolute pressure module so that the module is not rezeroed every time it is used.

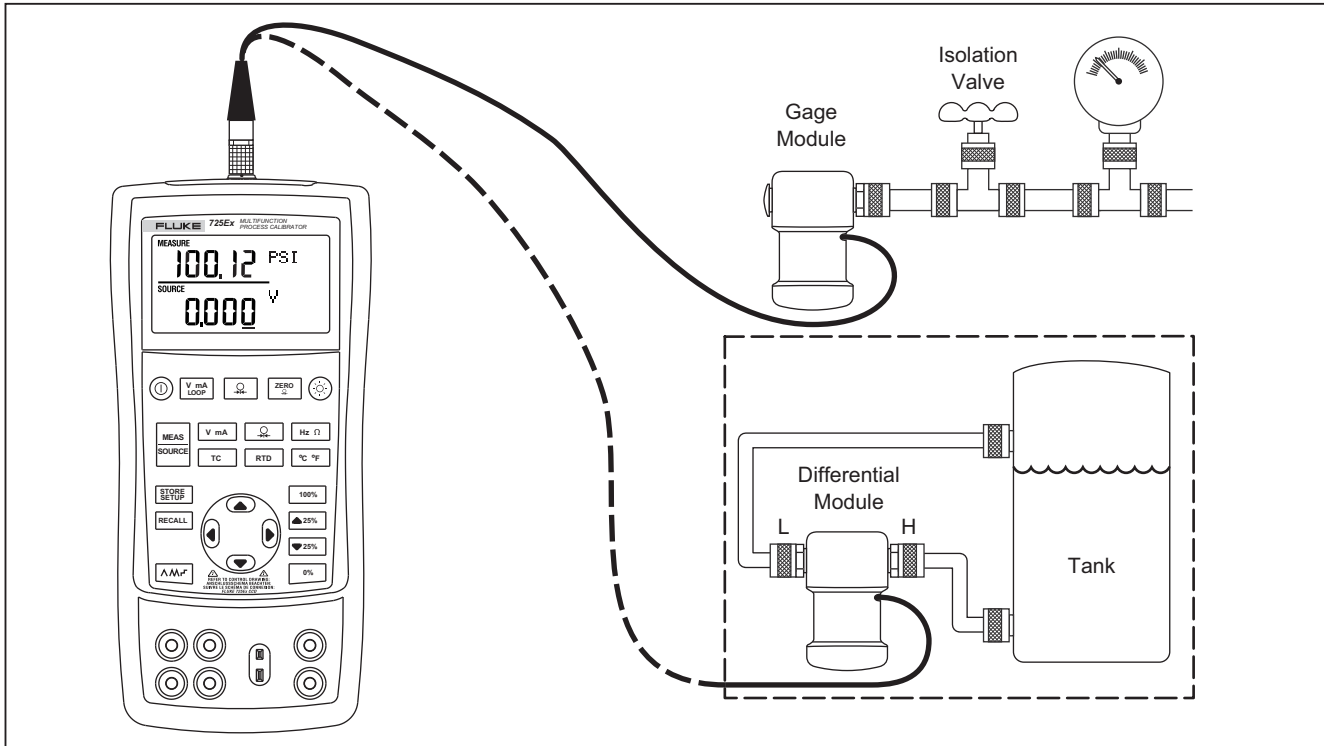

Figure 13. Connections for Measuring Pressure







aly37f.eps

Using Source Mode

In SOURCE mode, the Calibrator generates calibrated signals for testing and calibrating process instruments; supplies voltages, currents, frequencies, and resistances; simulates the electrical output of RTD and thermocouple temperature sensors; and measures gas pressure from an external source, creating a calibrated pressure source.

Sourcing 4 to 20 mA





To select the current sourcing mode, proceed as follows:

1. Connect the test leads in the mA terminals (left column).
2. If necessary, press  for SOURCE mode.
3. Press  for current and enter the desired current by pressing  and  keys. Press  and  to select a different digit to change.

Simulating a 4- to 20-mA Transmitter

Simulate is a special mode of operation in which the Calibrator is connected into a loop in place of a transmitter and supplies a known, settable test current. Proceed as follows:







Connect the 12-V-loop-power source as shown in Figure 14.

1. If necessary, press  for SOURCE mode.
2. Press  until both mA and SIM display.
3. Enter the desired current by pressing  and  keys.

Sourcing Other Electrical Parameters

Volts, ohms, and frequency are also sourced and shown in the lower display.

To select an electrical sourcing function, proceed as follows:

1. Connect the test leads as shown in Figure 15, depending on the source function.
2. If necessary, press  for SOURCE mode.
3. Press  for dc voltage, or  for frequency or resistance.
4. Enter the desired output value by pressing  and  keys. Press  and  to select a different digit to change.

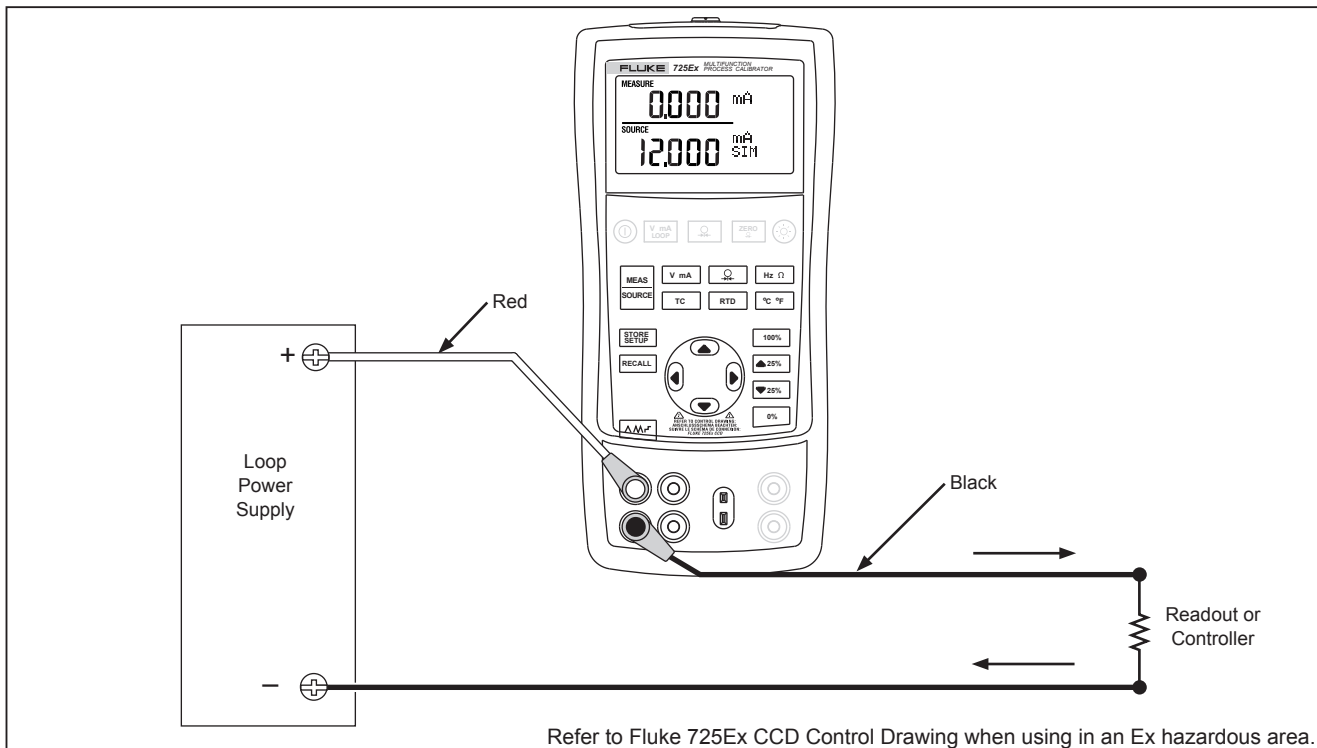

aly17f.eps

Figure 14. Connections for Simulating a 4 to 20- mA Transmitter in a non-Ex hazardous Area

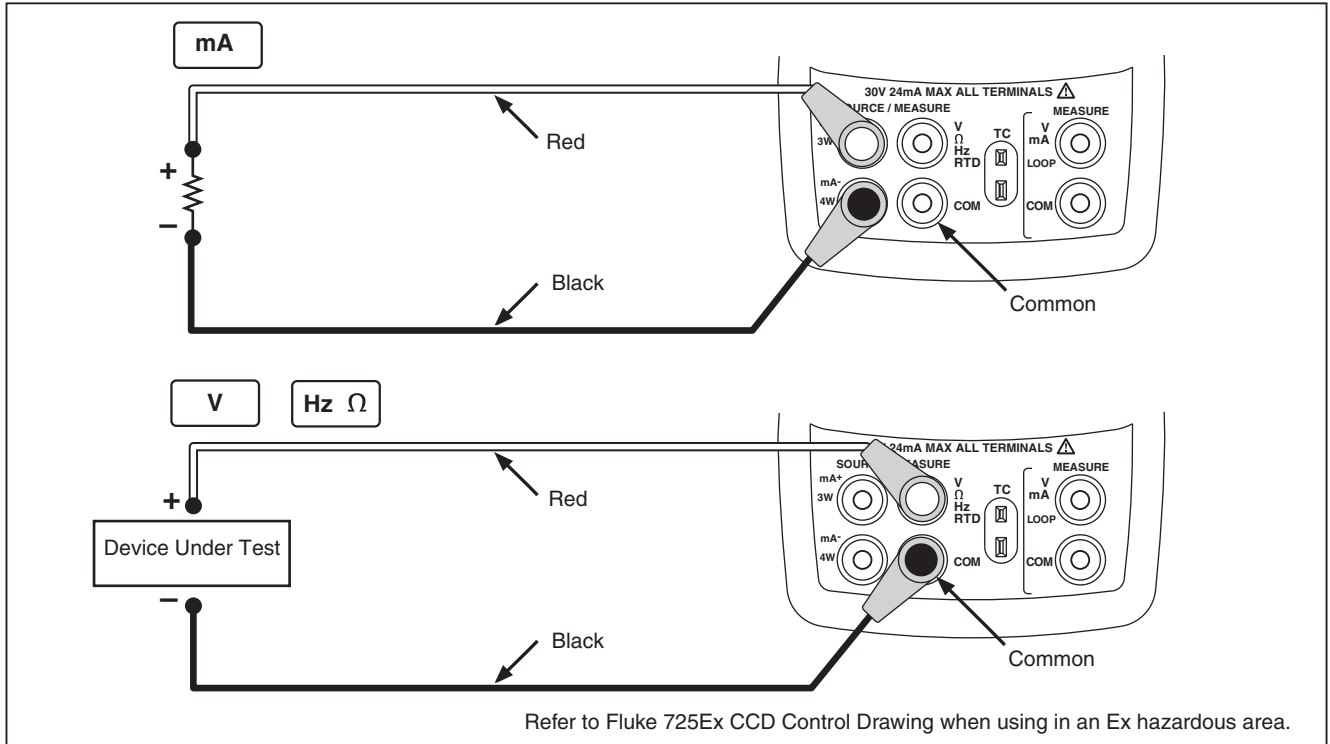

Figure 15. Electrical Sourcing Connections







Simulating Thermocouples

Connect the Calibrator TC input/output to the instrument under test with thermocouple wire and the appropriate thermocouple mini-connector (polarized thermocouple plug with flat, inline blades spaced 7.9 mm [0.312 in] center to center).

Caution

One pin is wider than the other. Do not try to force a miniplug in the wrong polarization.

Figure 16 shows this connection. Proceed as follows to simulate a thermocouple:

1. Attach the thermocouple leads to the appropriate TC miniplug, then to the TC input/output as shown in Figure 16.
2. If necessary, press  for SOURCE mode.
3. Press  for the TC display. If desired, continue pressing this key to select the desired thermocouple type.
4. Enter the desired temperature by pressing  and  keys. Press  and  to select a different digit to edit.





Simulating RTDs

Connect the Calibrator to the instrument under test as shown in Figure 17. Proceed as follows to simulate an RTD:

1. If necessary, press  for SOURCE mode.
2. Press  for the RTD display.

Note

Use the 3W and 4W terminals for measurement only, not for simulation. The Calibrator simulates a 2-wire RTD at its front panel. To connect to a 3-wire or 4-wire transmitter, use the stacking cables to provide the extra wires. See Figure 17.

3. Enter the desired temperature by pressing  and  keys. Press  and  to select a different digit to edit.

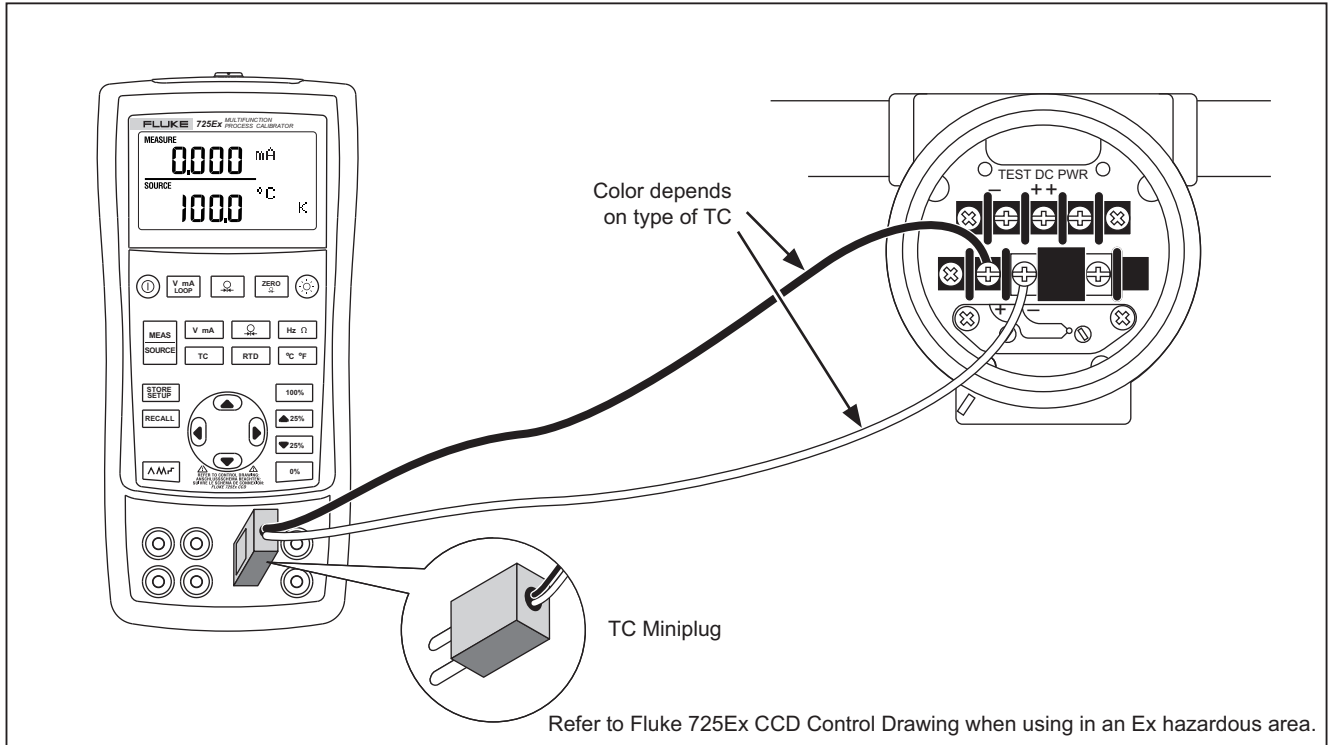

Figure 16. Connections for Simulating a Thermocouple

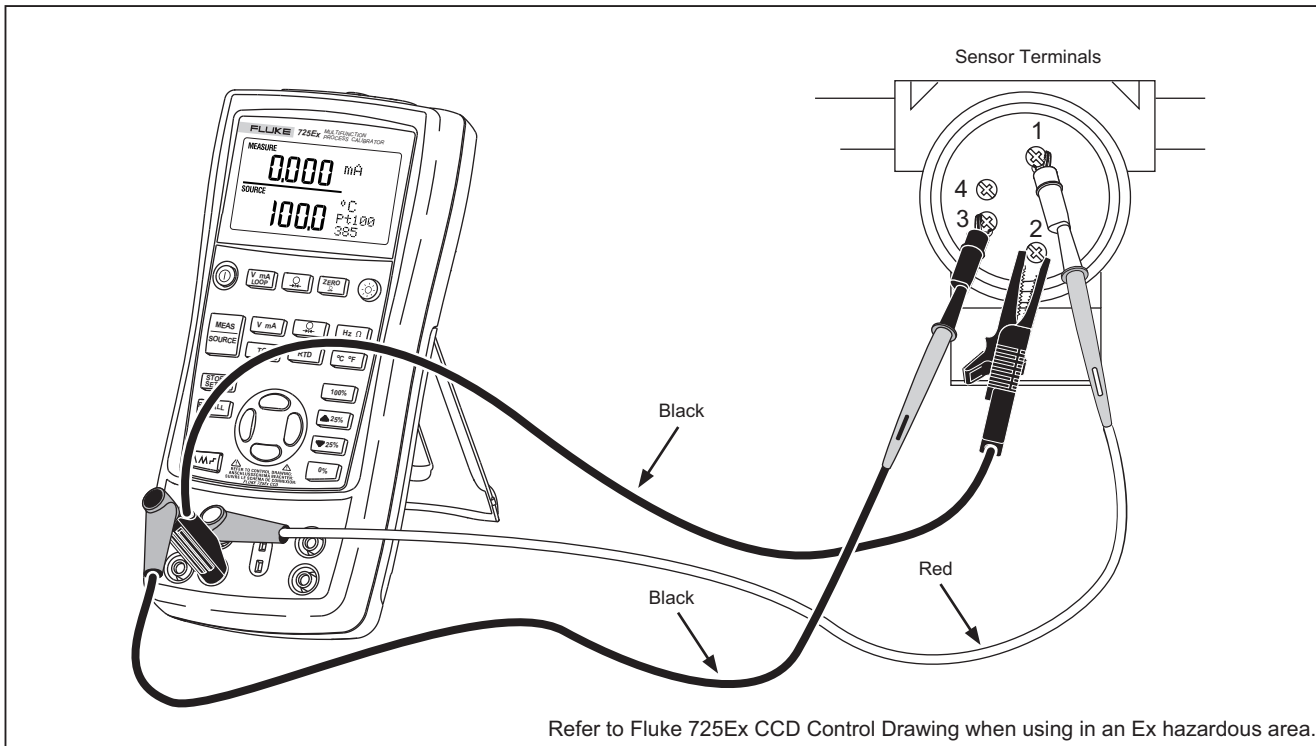

Figure 17. Connections for Simulating 3-Wire RTD

aly40f.eps

Source Pressure Mode

The Calibrator can be used to monitor the pressure supplied by a pump or other sources, and will display the pressure in the SOURCE field. Figure 18 shows how to connect a pump to a Fluke pressure module which makes it a calibrated source.

Attach the appropriate pressure module for the process pressure to be tested.

Proceed as follows to source pressure:

Warning



To prevent fire, explosion, or personal injury:

- Use only Fluke pressure modules.
- To avoid a violent release of pressure in a pressurized system, shut off the valve and slowly bleed off the pressure before attaching the pressure module to the pressure line.

Caution

- To avoid mechanically damaging the pressure module, never apply more than 10 lb-ft (13.5 Nm) of torque between the pressure module fittings, or between the fittings and the body of the module. Always apply appropriate torque between the pressure module fitting and connecting fittings or adapters.
- To avoid damaging the pressure module from overpressure, never apply pressure above the rated maximum printed on the pressure module.
- To avoid damaging the pressure module from corrosion, use it only with specified materials. Refer to the printing on the pressure module or the pressure module instruction sheet for the acceptable material compatibility.

Connect a pressure module to the Calibrator as shown in Figure 18. The threads on the pressure modules accept standard ¼ NPT pipe fittings. Use the supplied ¼ NPT to ¼ ISO adapter if necessary.

1. Press  (lower display). The Calibrator automatically senses which pressure module is attached and sets its range accordingly.
 2. Zero the pressure module as described in the module's Instruction Sheet. Modules vary in zeroing procedures depending on module type.
 3. Pressurize the pressure line with the pressure source to the desired level as shown on the display.
- If desired, continue pressing  to change pressure display units to psi, mmHg, inHg, cmH₂O@4 °C, cmH₂O@20 °C, inH₂O@4 °C, inH₂O@20 °C, inH₂O@60 °F, mbar, bar, kg/cm², or kPa.

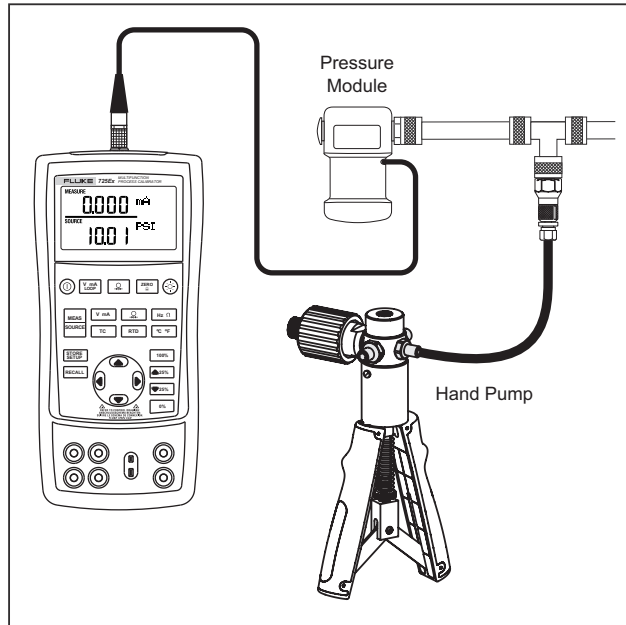





Figure 18. Connections for Sourcing Pressure



aly19f.eps

Setting 0 % and 100 % Output Parameters

For current output, the Calibrator assumes that 0 % corresponds to 4 mA and 100 % corresponds to 20 mA. For other output parameters, the 0 % and 100 % points must be set before use of the step and ramp functions. Proceed as follows:



1. If necessary, press  for SOURCE mode.
2. Select the desired source function and use the arrow keys to enter the value. Our example is temperature source using 100 °C and 300 °C values for source.
3. Enter 100 °C and press and hold  to store the value.
4. Enter in 300 °C and press and hold  to store the value.

This setting may now be used for the following:

- Manually stepping an output with 25 % increments.
- Jump between the 0 % and 100 % span points by momentarily pushing  or .

Stepping and Ramping the Output





Two features are available for adjusting the value of source functions.

- Stepping the output manually with the  and  keys, or in automatic mode.
- Ramping the output.

Stepping and ramping apply to all functions except pressure, which requires use of an external pressure source.

Manually Stepping the mA Output

To manually step current output, do the following:

- Use  or  to step the current up or down in 25 % steps.
- Touch momentarily either  to go to 0 %, or  to go to 100 %.

Auto Ramping the Output

Auto ramping gives the ability to continuously apply a varying stimulus from the Calibrator to a transmitter, while your hands remain free to test the response of the transmitter.

When  is pressed, the Calibrator produces a continuously repeating 0 % - 100 % - 0 % ramp in a choice of three ramp waveforms:

 0 % - 100 % - 0 % 40-second smooth ramp

 0 % - 100 % - 0 % 15-second smooth ramp

 0 % - 100 % - 0 % Stair-step ramp in 25 % steps, pausing 5 seconds at each step. Steps are listed in Table 7.

To exit ramping, press any button.





Table 7. mA Step Values

Step	4 to 20 mA
0 %	4.000
25 %	8.000
50 %	12.000
75 %	16.000
100 %	20.000





Storing and Recalling Setups

Store up to eight settings in a nonvolatile memory and recall the settings for later use. A low battery condition or a battery change does not jeopardize the stored settings.

Proceed as follows:

1. After creating a calibrator setup, press . In the display, the memory locations appear.
2. Press  or  to select locations one through eight. An underscore appears below the selected memory location.
3. Press  until the memory number disappears then reappears. The setup is stored.













To recall setups, proceed as follows.

1. Press . The memory locations appear on the display.
2. Press  or  to select the appropriate location and press .

Calibrating a Transmitter

Use the measurement (upper display) and source (lower display) modes to calibrate a transmitter. This section applies to all but pressure transmitters. The following example shows how to calibrate a temperature transmitter.

Connect the Calibrator to the instrument under test as shown in Figure 19. Proceed as follows to calibrate a transmitter

1. Press  for current (upper display). If required, press  again to activate loop power.
2. Press  (lower display). If desired, continue pressing this key to select the desired thermocouple type.
3. If necessary, press  for SOURCE mode.
4. Set the zero and span parameters by pressing  and  keys. Enter these parameters by pressing and holding  and . For more information on setting parameters, see "Setting 0 % and 100 %" earlier in this manual.
5. Press  or  to select the appropriate location
6. Perform test checks at 0-25-50-75-100 % points by pressing  or . Adjust the transmitter as necessary.

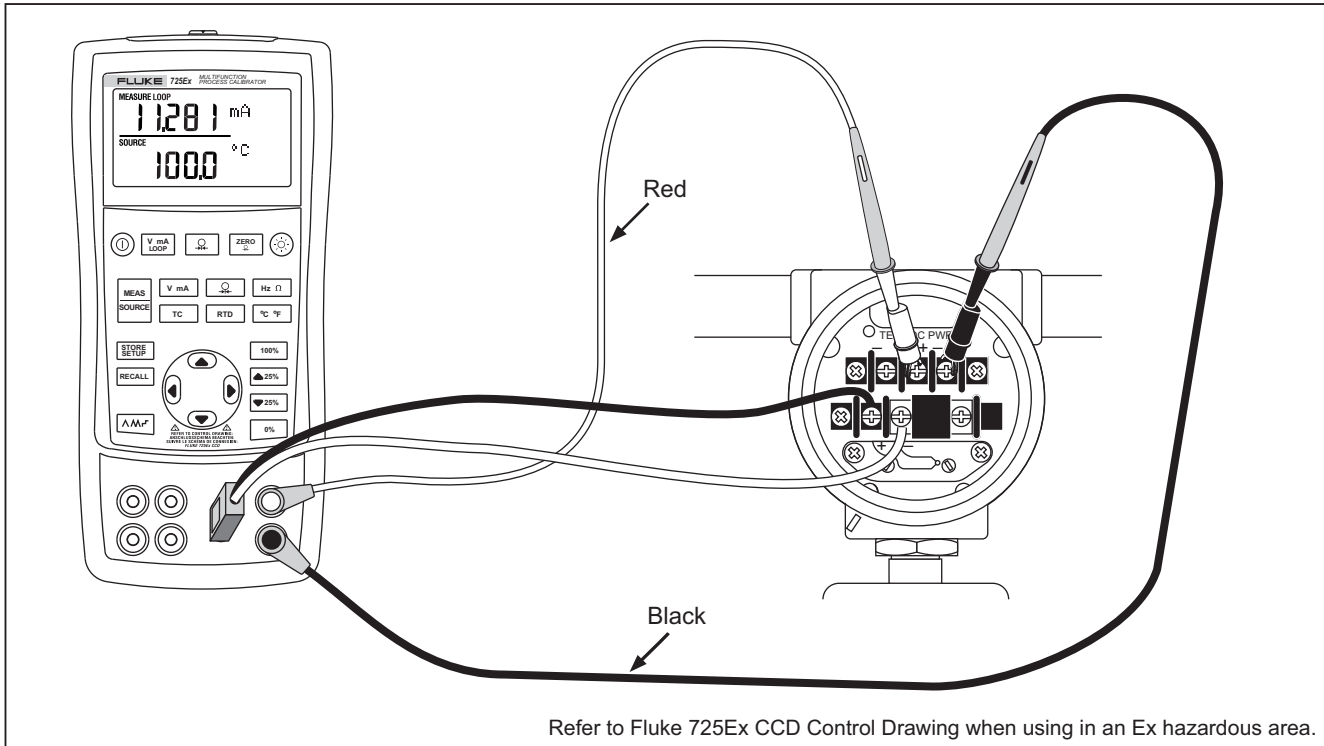

Refer to Fluke 725Ex CCD Control Drawing when using in an Ex hazardous area.





Figure 19. Calibrating a Thermocouple Transmitter

aly44f.eps

Calibrating a Pressure Transmitter

The following example shows how to calibrate a pressure transmitter.

Connect the Calibrator to the instrument under test as shown in Figure 20. Proceed as follows:

1. Press  for current (upper display). If required, press  again to activate loop power.
2. Press  (lower display).
3. If necessary, press  for SOURCE mode.
4. Zero the pressure module.
5. Perform checks at 0 % and 100 % of span and adjust the transmitter as necessary.

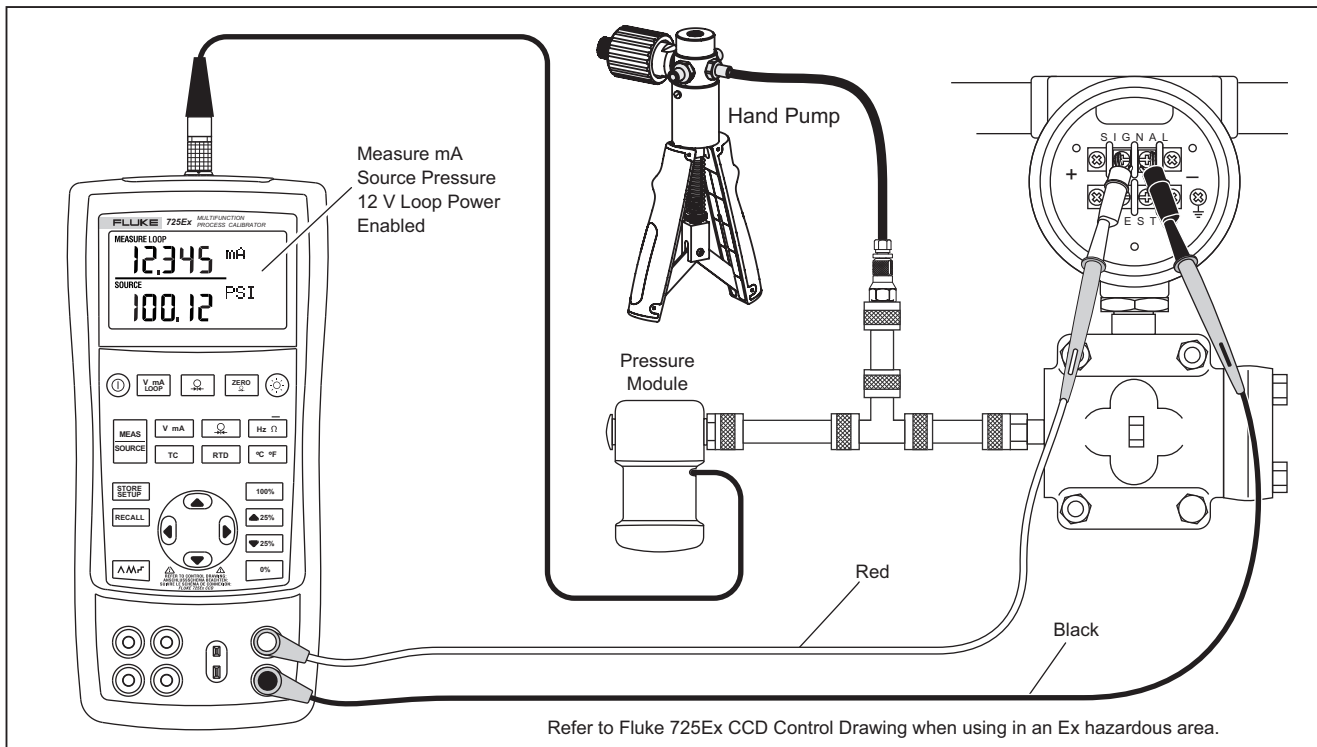









Figure 20. Calibrating a Pressure-to-Current (P/I) Transmitter

aly34f.eps

Calibrating an I/P Device

The following test allows calibration of a device that controls pressure. Proceed as follows:

1. Connect the test leads to the instrument under test as shown in Figure 21. The connections simulate a current-to-pressure transmitter and measures the corresponding output pressure.
2. Press  (upper display).
3. Press  for sourcing current (lower display).
4. If necessary, press  for SOURCE mode.
5. Enter the desired current by pressing  and  keys. Press  and  to select different digits.

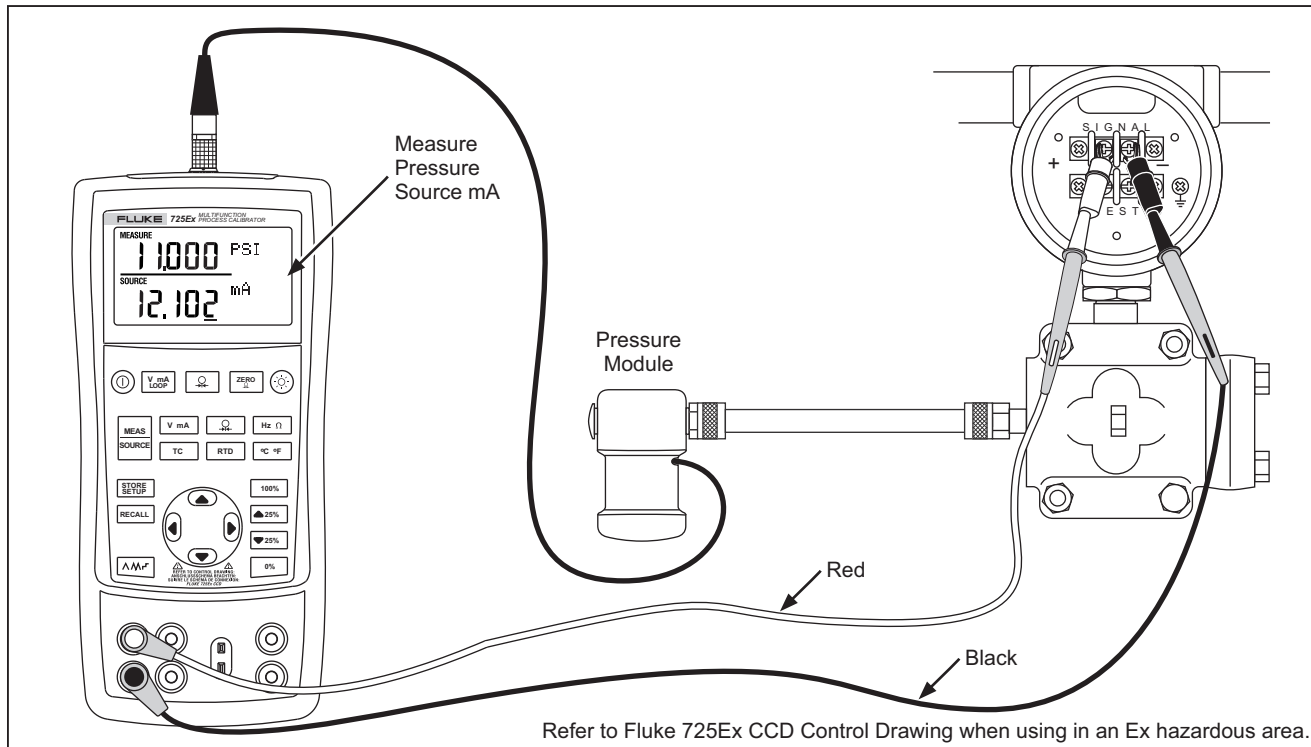

Refer to Fluke 725Ex CCD Control Drawing when using in an Ex hazardous area.

aly28f.eps

Figure 21. Calibrating a Current-to-Pressure (I/P) Transmitter

Switch Test

To perform a switch test, follow these steps:



Note

*This example used a normally closed switch.
The procedure is the same for an open switch
but the display reads OPEN instead of CLOSE.*

1. Connect the Calibrator mA and COM terminals to the switch using the pressure switch terminals and connect the pump from the Calibrator to the pressure switch. The polarity of the terminals does not matter.
2. Make sure the vent on the pump is open and zero the Calibrator if necessary. Close the vent after zeroing the Calibrator.
3. Press and hold the upper display  button for three seconds to enter switch test mode. The upper main display indicates the applied pressure, CLOSE will be displayed to the right of the pressure reading to indicate closed contacts
4. Apply pressure with the pump slowly until the switch opens.

Note

Pressure the device slowly to ensure accurate readings. Run the test several times to confirm repeatability.

5. OPEN displays once the switch is open. Bleed the pump slowly until the pressure switch closes. RECALL appears on the display.
6. Press  to read the pressure values for when the switch opened, for when it closed, and for the deadband.
7. Hold  for three seconds to exit the switch test or press  to clear the switch test and rerun the test.

Testing an Output Device

Use the source functions to test and calibrate actuators, recording, and indicating devices. Proceed as follows:

1. Connect the test leads to the instrument under test as shown in Figure 22.
2. Press V mA for current or dc voltage, or $\text{Hz } \Omega$ for frequency or resistance (lower display).
3. If necessary, press MEAS SOURCE for SOURCE mode.

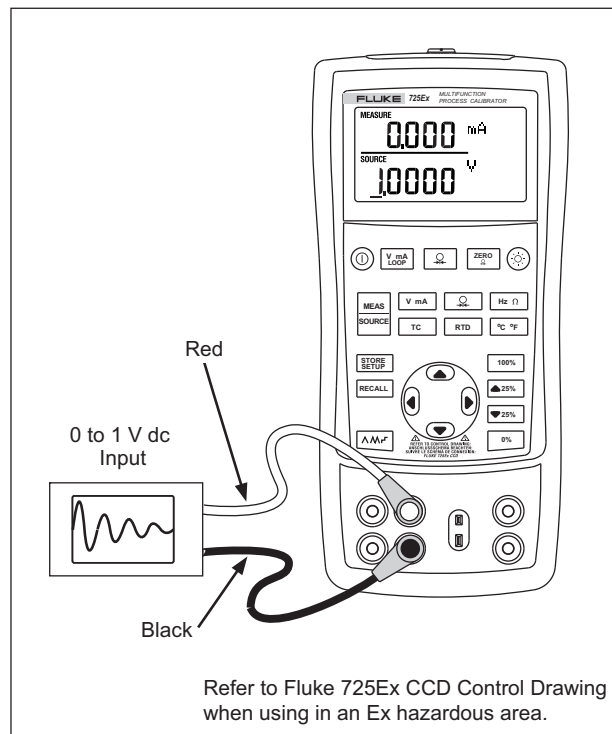

Figure 22. Calibrating a Chart Recorder

aly25f.eps

Replacing the Batteries

Warning

To prevent fire, explosion, or personal injury:

- Remove the Calibrator from the Ex-hazardous area before opening the battery door. See *Ex Hazardous Areas*.

Figure 23 shows how to replace the batteries.

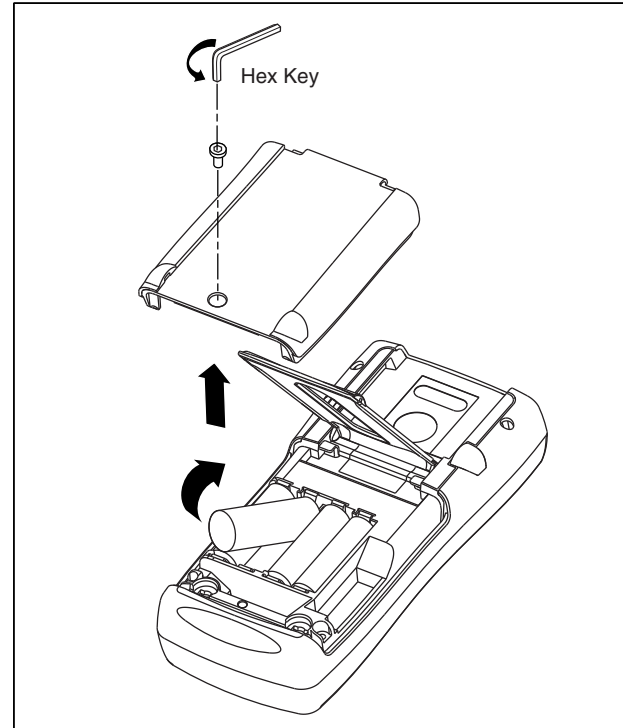

Figure 23. Replacing the Batteries

sh38f.eps

Approved Batteries

Table 8. Approved Batteries

Battery Manufacturer (All Batteries Alkaline- AA 1.5 V)	Type
Duracell	MN1500
Eveready (Energizer)	E91

Maintenance

Cleaning the Calibrator

Warning

To avoid personal injury or damage to the Calibrator, use only the specified replacement parts and do not allow water into the case.

Caution

To avoid damaging the plastic lens and case, do not use solvents or abrasive cleansers.

Clean the Calibrator and pressure modules with a soft cloth dampened with water or water and mild soap.

Service Center Calibration or Repair

Calibration, repairs, or servicing must be performed only by qualified service personnel. If the Calibrator fails, check the batteries first, and replace them if needed.

Verify that the Calibrator is being operated in accordance with the instructions in this manual. If the Calibrator is faulty, send a description of the failure with the Calibrator. Pressure modules do not need to accompany the Calibrator unless the module is faulty also. Be sure to pack the Calibrator securely, using the original shipping container if it is available. Send the equipment postage paid and insured, to the nearest Service Center. Fluke assumes no responsibility for damage in transit.

The Fluke 725Ex Calibrator covered by the warranty will be promptly repaired or replaced (at Fluke's option) and returned to you at no charge. See the back of the title page for warranty terms. If the warranty period has expired or the operating limits are exceeded, the

Calibrator will be repaired and returned for a fixed fee. If the Calibrator or pressure module is not covered under the warranty terms, contact an authorized service center for a price quote for repair.

To locate an authorized service center or order replacement parts, refer to "Contacting Fluke" at the beginning of the manual.

Replacement Parts

Table 9 lists the part number of each replaceable part.

Table 9. Replacement Parts

Description	PN	Qty.
AA alkaline batteries	See "Table 8. Approved Batteries"	4
Battery door	2097832	1
Accessory mount	2151981	1
Tilt stand	2097826	1
TL75 series test set Cap, Black Cap, Red	855742 3986568 3995524	1 1 1
Fluke – 7XX Test Lead Set	3397308	1
AC175 Alligator clip, red Alligator clip, black	4239092 4239050	1 1
Input Decal	690948	1
<i>Fluke 725Ex Control Drawing</i>	4926220	1
<i>Fluke 725Ex Safety Information</i>	2151996	1

Accessories

For more information about these accessories and their prices, contact a Fluke representative. Pressure Modules and Fluke model numbers (see Table 10) are listed below. (Differential models also operate in gage mode.) Contact a Fluke representative about new pressure modules not listed here.

- 700HTP-2 0 to 10,000 PSI Pump
- 700PTP-1 -11.6 to 600 PSI Pump
- 700TC1 and 700TC2 Thermocouple Mini-plug Kits

External Fluke Pressure Module Compatibility

The output of Fluke 750PEX pressure modules can cause the 5 digit display of the Calibrator to overflow, or else produce values that are too low to be read if inappropriate units are selected. This is prevented by displaying OL on the display per Table 10.

Table 10. Fluke Pressure Module Compatibility

Pressure Unit	Module Compatibility
psi	Available on all pressure ranges
inH ₂ O	All ranges through 3000 psi
cmH ₂ O	All ranges through 1000 psi
bar	15 psi and above
mbar	All ranges through 1000 psi
kPa	Available on all pressure ranges
inHg	Available on all pressure ranges
mmHg	All ranges through 1000 psi
kg/cm ²	15 psi and above

Table 11. Pressure Modules

Fluke Model Number	Range	Type and Media
Fluke-750P01Ex	0 inH2O to 10 inH2O	differential, Low: dry High: dry
Fluke-750P24Ex	0 psi to 15 psi	differential, Low: dry High: wet
Fluke-750P05Ex	0 psi to 30 psi	gage, wet
Fluke-750P06Ex	0 psi to 100 psi	gage, wet
Fluke-750P09Ex	0 psi to 1500 psi	gage, wet
Fluke-750P27Ex	0 psi to 300 psi	gage, wet
Fluke-750P29Ex	0 psi to 3000 psi	gage, wet
Fluke-750PA4Ex	0 psi to 15 psi	absolute, Low: dry High: wet

Specifications

All specifications apply from +18 °C to +28 °C unless stated otherwise. All specifications assume a 5-minute warmup period.

DC Voltage Measurement

Range	Resolution	Accuracy, (% of Reading + Counts)
30 V (upper display)	0.001 V	0.02 % + 2
10 V (lower display)	0.001 V	0.02 % + 2
90 mV	0.01 mV	0.02 % + 2
Temperature coefficient -10 °C to 18 °C, +28 °C to 55 °C: ±0.005 % of range per °C		

DC Voltage Source

Range	Resolution	Accuracy, (% of Reading + Counts)
100 mV	0.01 mV	0.02 % + 2
10 V	0.001 V	0.02 % + 2
Temperature coefficient -10 °C to 18 °C, +28 °C to 55 °C: ±0.005 % of range per °C		
Maximum load: 1 mA		

Millivolt Measurement and Source*

Range	Resolution	Accuracy
-10 mV to 75 mV	0.01 mV	±(0.025 % + 1 count)
Maximum input voltage: 30 V		
Temperature coefficient -10 °C to 18 °C, +28 °C to 55 °C: ±0.005 % of range per °C		
*Select this function by pressing TC . The signal is available at the thermocouple miniplug connector.		

DC mA Measurement and Source

Range	Resolution	Accuracy, (% of Reading + Counts)
24 mA	0.001 mA	0.02 % + 2
Temperature coefficient -10 °C to 18 °C, +28 °C to 55 °C: ±0.005 % of range per °C Drive capability: 250 Ω at 20 mA		

Ohms Measurement

Ohms Range	Accuracy ± Ω*	
	4-Wire	2- and 3-Wire
0 Ω to 400 Ω	0.1	0.15
400 Ω to 1.5 kΩ	0.5	1.0
1.5 kΩ to 3.2 kΩ	1	1.5

Temperature coefficient -10 °C to 18 °C, +28 °C to 55 °C: ±0.005 % of range per °C
Excitation Current: 0.2 mA
Maximum input voltage: 30 V
 * 2-wire: Does not include lead resistance.
 3-wire: Assumes matched leads with a total resistance not exceeding 100 Ω.

Ohms Source

Ohms Range	Excitation Current from Measurement Device	Accuracy ± Ω
15 Ω to 400 Ω	0.15 mA to 0.5 mA	0.15
15 Ω to 400 Ω	0.5 mA to 2 mA	0.1
400 Ω to 1.5 kΩ	0.05 mA to 0.8 mA	0.5
1.5 kΩ to 3.2 kΩ	0.05 mA to 0.4 mA	1
Temperature coefficient -10 °C to 18 °C, +28 °C to 55 °C: ± 0.005 % of resistance range per °C		
Resolution		
15 Ω to 400 Ω	0.1 Ω	
400 Ω to 3.2 kΩ	1 Ω	

Frequency Measurement

Range	Resolution	Accuracy
2.0 CPM to 1000.0 CPM	0.1 CPM	± (0.05 % + 1 count)
1 Hz to 1000 Hz	1.0 Hz	± (0.05 % + 1 count)
1.0 kHz to 10.0 kHz	0.1 kHz	± (0.05 % + 1 count)
Sensitivity: 1 V peak-to-peak minimum Waveform: squarewave		

Frequency Source

Range	Resolution	Accuracy (% of output frequency)
2.0 CPM to 1000.0 CPM	0.1 CPM	±0.05 %
1 Hz to 1000 Hz	1 Hz	±0.05 %
1.0 kHz to 10.0 kHz	0.1 kHz	±0.25 %
Waveform: 5 V p-p squarewave, -0.1 V offset		

Temperature, Thermocouples

Type	Range	Measure and Source Accuracies
J	-200 °C to 0 °C	1.0 °C
	0 °C to 1200 °C	0.7 °C
K	-200 °C to 0 °C	1.2 °C
	0 °C to 1370 °C	0.8 °C
T	-200 °C to 0 °C	1.2 °C
	0 °C to 400 °C	0.8 °C
E	-200 °C to 0 °C	0.9 °C
	0 °C to 950 °C	0.7 °C
R	-20 °C to 0 °C	2.5 °C
	0 °C to 500 °C	1.8 °C
	500 °C to 1750 °C	1.4 °C
S	-20 °C to 0 °C	2.5 °C
	0 °C to 500 °C	1.8 °C
	500 °C to 1750 °C	1.5 °C

Type	Range	Measure and Source Accuracies
B	600 °C to 800 °C	2.2 °C
	800 °C to 1000 °C	1.8 °C
	1000 °C to 1800 °C	1.4 °C
L	-200 °C to 0 °C	0.85 °C
	0 °C to 900 °C	0.7 °C
U	-200 °C to 0 °C	1.1 °C
	0 °C to 400 °C	0.75 °C
N	-200 to 0 °C	1.5 °C
	0 °C to 1300 °C	0.9 °C
XK	-200 °C to 100 °C	0.5 °C
	-100 °C to 800 °C	0.6 °C
BP	0 °C to 800 °C	1.2 °C
	800 °C to 2500 °C	2.5 °C
Resolution: 0.1 °C, 0.1 °F		

Loop Power Supply

Voltage: 12 V

Maximum current: 24 mA

Short circuit protected

RTD Excitation (simulation)

Allowable Excitation by RTD type	
Ni 120	0.15 mA to 3.0 mA
Pt 100-385	0.15 mA to 3.0 mA
Pt 100-3926	0.15 mA to 3.0 mA
Pt 100-3916	0.15 mA to 3.0 mA
Pt 200-385	0.05 mA to 0.80 mA
Pt 500-385	0.05 mA to 0.80 mA
Pt 1000-385	0.05 mA to 0.40 mA

Temperature, RTD Ranges, and Accuracies

Type	Range °C	Accuracy		
		Measure 4-Wire °C	Measure 2- and 3-Wire* °C	Source °C
Ni120	-80 to 260	0.2	0.3	0.2
Pt100-385	- 200 to 800	0.33	0.5	0.33
Pt100-3926	-200 to 630	0.3	0.5	0.3
Pt100-3916	-200 to 630	0.3	0.5	0.3
Pt200-385	-200 to 250	0.2	0.3	0.2
	250 to 630	0.8	1.6	0.8
Pt500-385	-200 to 500	0.3	0.6	0.3
	500 to 630	0.4	0.9	0.4
Pt1000-385	-200 to 100	0.2	0.4	0.2
	100 to 630	0.2	0.5	0.2

Resolution: 0.1 °C, 0.1 °F

RTD Source: Addresses pulsed transmitters and PLCs with pulses as short as 5 ms.

* 2-wire: Does not include lead resistance.

3-wire: Assumes matched leads with a total resistance not exceeding 100 Ω.

Pressure Measurement

Range	Resolution	Accuracy	Units
Determined by pressure module	5 digits	Determined by pressure module	psi, inH2O@4 °C, inH2O@20 °C, inH2O@60 °F, kPa, cmH2O@4 °C, cmH2O@20 °C, bar, mbar, kg/cm2, mmHg, inHg

General Specifications

Operating temperature	-10 °C to 55 °C
Storage temperature	- 20 °C to 71 °C
Operating altitude	3000 meters above mean sea level
Pollution Degree	2
Relative Humidity (% RH operating without condensation)	90 % (10 °C to 30 °C) 75 % (30 °C to 40 °C) 45 % (40 °C to 50 °C) 35 % (50 °C to 55 °C) uncontrolled <10 °C
Vibration	Random, 2 g, 5 Hz to 500 Hz

<p>Electromagnetic compatibility (EMC) International</p> <p>Korea (KCC)</p> <p>USA (FCC)</p>	<p>IEC 61326-1: Portable</p> <p>CISPR 11: Group 1, Class A</p> <p><i>Group 1: Equipment has intentionally generated and/or uses conductively-coupled radio frequency energy that is necessary for the internal function of the equipment itself.</i></p> <p><i>Class A: Equipment is suitable for use in all establishments other than domestic and those directly connected to a low-voltage power supply network that supplies buildings used for domestic purposes. There may be potential difficulties in ensuring electromagnetic compatibility in other environments due to conducted and radiated disturbances.</i></p> <p><i>Caution: This equipment is not intended for use in residential environments and may not provide adequate protection to radio reception in such environments.</i></p> <p>Class A Equipment (Industrial Broadcasting & Communication Equipment)</p> <p><i>Class A: Equipment meets requirements for industrial electromagnetic wave equipment and the seller or user should take notice of it. This equipment is intended for use in business environments and not to be used in homes.</i></p> <p>47 CFR 15 subpart B. This product is considered an exempt device per clause 15.103.</p>
Power requirements	4 AA alkaline batteries- See "Approved Batteries"
Size	96 mm x 200 mm x 47 mm (3.75 in x 7.9 in x 1.86 in)
Weight	650 gm (1 lb, 7 oz)

Entity Parameters

For Entity Parameters, Refer to Fluke 725Ex CCD, Control Drawing for use in Ex hazardous areas.