

719 Series

Pressure Calibrator with Electric Pump

Users Manual

August 2008

© 2008 Fluke Corporation. All rights reserved. Specifications are subject to change without notice.
All product names are trademarks of their respective companies.

LIMITED WARRANTY AND LIMITATION OF LIABILITY

This Fluke product will be free from defects in material and workmanship for three years (one year for pump assembly) from the date of purchase. This warranty does not cover fuses, disposable batteries or damage from accident, neglect, misuse or abnormal conditions of operation or handling. Resellers are not authorized to extend any other warranty on Fluke's behalf. To obtain service during the warranty period, send your defective Calibrator to the nearest Fluke Authorized Service Center with a description of the problem.

THIS WARRANTY IS YOUR ONLY REMEDY. NO OTHER WARRANTIES, SUCH AS FITNESS FOR A PARTICULAR PURPOSE, ARE EXPRESSED OR IMPLIED. FLUKE IS NOT LIABLE FOR ANY SPECIAL, INDIRECT, INCIDENTAL OR CONSEQUENTIAL DAMAGES OR LOSSES, ARISING FROM ANY CAUSE OR THEORY. Since some states or countries do not allow the exclusion or limitation of an implied warranty or of incidental or consequential damages, this limitation of liability may not apply to you.

Fluke Corporation
P.O. Box 9090
Everett, WA 98206-9090
U.S.A.

Fluke Europe B.V.
P.O. Box 1186
5602 BD Eindhoven
The Netherlands

Table of Contents

Title	Page
Introduction	1
Safety Information	2
Getting Acquainted with the Calibrator	5
HART Resistor.....	8
Power Saver.....	8
Switch Test.....	8
Zeroing with Absolute Pressure Modules	9
Set Maximum Pressure Limit	10
Calibrating a P/I Transmitter.....	10
Using the Internal Pump.....	10
Pump Valve Assembly Cleaning Instructions	15
Using an External Pump.....	15
External Fluke Pressure Module Compatibility.....	17
Supplying Loop Power	18
mA Modes	18

Sourcing 4 to 20 mA	19
Simulating a 4 to 20mA Transmitter.....	19
Percent Error Setup	21
Maintenance	21
In Case of Difficulty	21
Cleaning.....	21
Replacing the Batteries.....	22
Calibration	22
Parts and Accessories	23
Specifications	26
Pressure Sensor Input	26
Pressure Module Input.....	26
DC mA Measure and Source	26
Loop Supply.....	26
Pressure Source	26
General Specifications	27
Contacting Fluke.....	27

List of Tables

Table	Title	Page
1.	Symbols.....	4
2.	Front Panel Features.....	5
3.	Pushbutton Functions.....	6
4.	Pump Features.....	7
5.	Recommended Pressure Modules	14
6.	Fluke Pressure Module Compatibility	17
7.	Replacement Parts	23

List of Figures

Figure	Title	Page
1.	Connection Technique	4
2.	Front Panel Features.....	5
3.	Pump Features	7
4.	Internal Pressure Sensor with Internal Pump	12
5.	Pressure Module with Internal Pump.....	13
6.	Pressure Module with External Pump	16
7.	Sourcing Loop Voltage	18
8.	Sourcing mA Connections.....	19
9.	Connections for Simulating a 4 to 20 mA Transmitter	20
10.	Battery Replacement.....	22
11.	Replacement Parts	25

Introduction

The 719 30G and 100G Series Pressure Calibrators (the Calibrator) perform the following functions:

- Calibrate P/I (pressure to current) transmitters
- Calibrate I/P (current to pressure) devices
- Identify the set, reset and deadband of of pressure switches
- Measure pressure via a 1/8-in. NPT pressure fitting and an internal pressure sensor or via a Fluke 700 Series Pressure Module
- Source pressure via electric pump
- Measure, source, and simulate current up to 24 mA
- Simultaneously displays pressure and current
- Supply loop voltage
- Calculate mA percentage in Percent Mode
- Calculate mA error % in Percent Error Mode
- Switch between pressure/vacuum control

The Calibrator features:

- Precision air bleed for fine control
- Fine vernier adjustment for the pump
- A serviceable electric pump
- Pressure limit settings
- HART resistor mode

The Calibrator ships with:

- holster
- two installed 9 V alkaline batteries
- TL75 test leads
- AC70A alligator clips
- hose kit
- Product Overview Manual
- CD-ROM (Users Manual)

The Calibrator makes 5-digit pressure measurements in the units shown below:

- Psi
- inH₂O at 4 °C
- inH₂O at 20 °C
- kPa
- cmH₂O at 4 °C
- cmH₂O at 20 °C
- bar
- mbar
- kg/cm²
- inHg
- mmHg

For pressure modules, full-scale readings for all pressure ranges can be made in:

- Psi
- kPa
- inHg

To avoid display overflow, full scale readings are limited to 1000 psi in cmH₂O, mbar, and mmHg units, and 3000 psi in inH₂O units. Pressures of at least 15 psi must be measured for meaningful readings in bar and kg/cm² units.

Safety Information

A **Warning** identifies conditions and actions that pose hazard(s) to the user; a **Caution** identifies conditions and actions that may damage the Calibrator or the equipment under test. Symbols used in this manual and on the Calibrator are listed in Table 1.

⚠ ⚠ Warning

To avoid possible electric shock or personal injury:

- **Use the Calibrator only as specified in this manual, otherwise the protection provided by the Calibrator may be impaired.**
- **Never apply more than 30 V, including transients, between the mA terminals, or between either of the mA terminals and earth ground.**
- **The Calibrator is rated for CAT I measurement only. Do not use the Calibrator to make measurements in a CAT II, CAT III, or CAT IV environments. CAT I equipment is designed to protect against transient from high-voltage, low-energy sources, such as electronic circuits or a copy machine**
- **Remove the test leads from the Calibrator before opening the battery door.**

- **Make sure the battery door is closed and latched before operating the Calibrator.**
- **Do not operate the Calibrator if it is damaged.**
- **Do not operate the Calibrator around explosive gas, vapor, or dust.**
- **When using probes, keep fingers behind the finger guards on the probes.**
- **Use only two 9 V batteries, properly installed in the Calibrator case, to power the Calibrator.**
- **Follow all equipment safety procedures.**
- **Turn off circuit power before connecting the Calibrator mA and COM terminals in the circuit. Place Calibrator in series with the circuit.**
- **When servicing the Calibrator, use only specified replacement parts.**
- **Do not allow water inside the case.**
- **To avoid false readings, which could lead to possible electric shock or personal injury, replace the battery as soon as the battery indicator (+) appears.**
- **To avoid a violent release of pressure in a pressurized system, shut off the valve and slowly bleed off the pressure before attaching or detaching the internal pressure sensor or pressure module fitting to the pressure line.**
- **To avoid over pressure damages, do not apply pressure that exceeds the limits listed in the Pressure Specifications table in the Specifications section.**
- **To avoid mechanically damaging the Calibrator, do not apply torque between the pressure fitting and the Calibrator case. See Figure 1 for the proper use of tools.**
- **To avoid misleading readings, disconnect the pressure module connector at the Calibrator.**
- **To avoid damage to the pressure module, refer to the related Instruction Sheet.**
- **To avoid damage to the pump, use with dry air and non-corrosive gases only.**
- **Check test leads for continuity before using. Inspect Calibrator for cracks or damage, do not use the probes if they are damaged or show high resistance.**

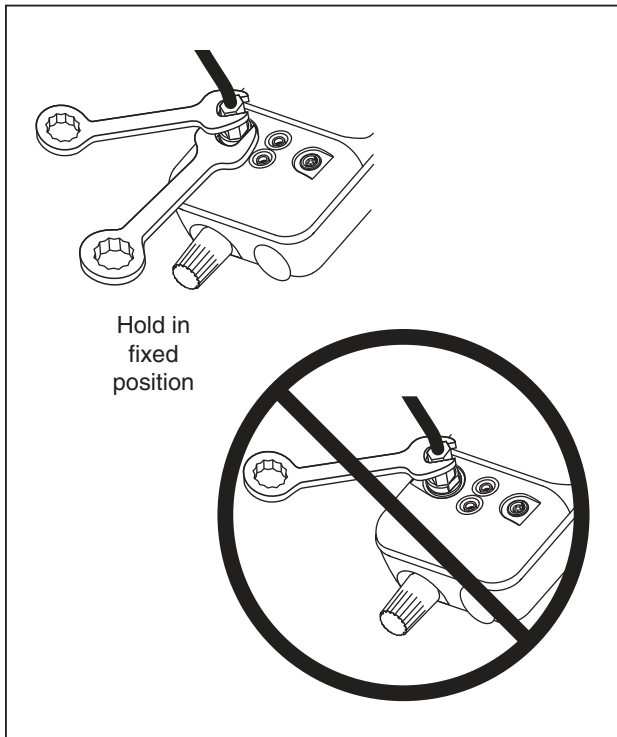

fgx001f.eps

Figure 1. Connection Technique

Table 1. Symbols

Symbol	Meaning
	Earth ground
	Battery
	Caution: Important information. Refer to instruction sheet
	Hazardous voltage. Risk of electric shock.
	Double insulated
	Conforms to relevant Canadian Standards Association directives.
	Conforms to European Union requirements
	Pressure
	Do not dispose of this product as unsorted municipal waste. Go to Fluke's website for recycling information.
	Conforms to relevant Australian standards.

Getting Acquainted with the Calibrator

The Calibrator displays pressure and current measurements simultaneously. See Table 2 and Figure 2 for front panel features.

The upper display shows the applied pressure or vacuum (shown as a negative value). Press **ENTER** then **UNITS** to select a different unit. When the power is cycled off and on, the Calibrator retains the unit last selected.

The lower section of the display shows the current (up to 24 mA) applied to the current (mA) inputs, or the mA output value.

To source loop voltage, press **ZERO** while pressing **ON**. Pushbutton operation is described in Table 3. Pump features are shown in Figure 3 and described in Table 4.

Table 2. Front Panel Features



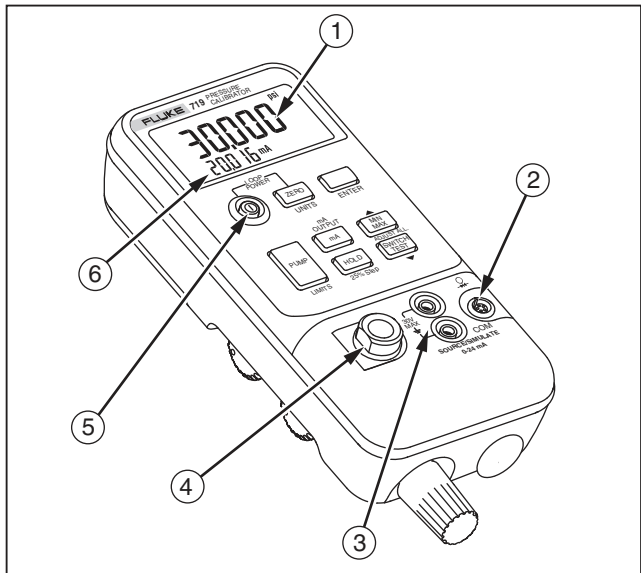













Item	Feature
①	Pressure Measurement
②	Pressure Module Input
③	Current Terminals
④	Pressure Sensor Input (install filter here)
⑤	Power Button
⑥	Current mA Measurement and Source



Fgx005f.eps

Figure 2. Front Panel Features

Table 3. Pushbutton Functions

Pushbutton	Description
 	<p>Press to zero the pressure display. Vent pressure to atmosphere before pressing. With an Absolute Pressure Module, see special instructions below. Press  then UNITS to change pressure units. Continue to press UNITS for next selection or use  to move back or  to move forward. Press ENTER when finished or await timeout. All units are available when the pressure sensor input is used. For higher pressure module inputs, out-of-range units are not available. Press  while pressing  to source loop voltage.</p>
	<p>Press to read the minimum pressure and current readings since power was turned on or the registers were cleared. Press again to read the maximum pressure and current readings since power was turned on. Press and hold for 3 seconds to clear the MIN/MAX registers. Us as the up arrow in select functions.</p>
	<p>Press to perform switch test. Used as a down arrow in select functions.</p>
 	<p>Press to toggle the mA display mode between mA, mA Percent, mA Percent Error, mA source and mA simulate.</p>
 25% Step	<p>Press  to freeze the display. HOLD appears on the display. Press  again to resume normal operation. When in mA source mode, press to step output in 25 % intervals of full scale (20 mA).</p>
 ENTER	<p>Press to enter or shift to units and limits functions. Press again to return to normal operation.</p>
 LIMITS	<p>Press to activate pump and source pressure/vacuum. Press  then LIMITS to set maximum pressure limit.</p>

Pressure Calibrator with Electric Pump
Getting Acquainted with the Calibrator

Table 4. Pump Features

Item	Description
①	Internal Pump- Press  to activate internal electric pump and source pressure/vacuum.
②	Pressure Vacuum Switch- Rotate forward (clockwise) for pressure, backward (counter-clockwise) for vacuum.
③	Pressure/Vacuum Release Valve- Rotate fully backward (counter-clockwise) to release all pressure or vacuum. (Rotate slightly for partial release.) Rotate fully forward (clockwise) to close valve.
④	Fine Adjustment Knob-Rotate either direction for precise adjustment of applied pressure or vacuum. Full rotation is about 30 turns.

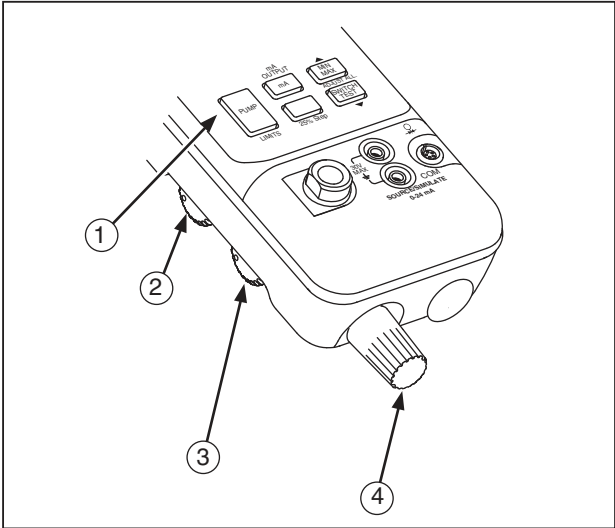

fgx009f.eps

Figure 3. Pump Features

HART Resistor

The Calibrator has a selectable 250 Ω HART resistor to facilitate use with HART communication devices. Use a HART communicator when measuring mA with loop power or sourcing mA. The HART resistor defaults to OFF.

To turn on the HART resistor:

1. With the Calibrator OFF, press \odot .
2. When **HARt** is displayed, press \blacktriangledown or \blacktriangle to turn on/off.

Power Saver

The Calibrator automatically turns off after 30 minutes of inactivity. To reduce this time or disable this feature:

1. With the Calibrator OFF, press \odot .
2. **P.S. xx** is displayed, where **xx** is the turn-off time in minutes. **OFF** means the power saver is disabled.
3. Press \blacktriangledown or \blacktriangle to decrease or increase the turn-off time.
4. To disable, press \blacktriangledown until the display shows **OFF**.

The Calibrator resumes normal operation after 2 seconds.

Switch Test

To perform a switch test:

Note

*This example uses a normally closed switch. The procedure is the same for an open switch but the display reads **OPEN** instead of **CLOSE**.*

1. Connect the Calibrator mA and COM terminals to the switch using the pressure switch terminals and connect an external pump between the Calibrator and the pressure switch. The polarity of the terminals does not matter.

Note

If using an external pump, connect the pump to the Calibrator and to the input of the switch using a tee fitting.

2. Make sure the vent on the pump is open and zero the Calibrator if necessary. Close the vent after zeroing the Calibrator.

3. Press  to enter pressure switch test mode. The Calibrator will display **CLOSE** instead of a mA measurement.
4. Apply pressure with the pump slowly until the switch opens.

Note





In the switch test mode, the display update rate is increased to help capture changing pressure inputs. Even with the enhanced sample rate, pressuring the device under test should be done slowly to ensure accurate readings.

5. **OPEN** is displayed once the switch is open. Bleed the pump slowly until the pressure switch closes. **RCL** appears on the display.
6. Press  to read the pressure values for when the switch opened, for when it closed, and for the deadband

Hold  for 3 seconds to reset Switch Test mode; press any other key to exit.

Zeroing with Absolute Pressure Modules

For zeroing, adjust the Calibrator to read a known pressure. This can be barometric pressure, if it is accurately known, for all but the 700PA3 module. An accurate pressure standard can also apply a pressure within range for any Absolute Pressure Module. Adjust the Calibrator reading as follows:

1. Press and hold .
2. Press  to increase or  to decrease the Calibrator reading to equal the applied pressure.
3. Release  to exit the zeroing procedure.

Set Maximum Pressure Limit

To set a maximum pressure limit for the internal electric pump:

1. Press then LIMITS and the limit setting is displayed.
2. Use ▲ to increase or ▼ the limit setting.
3. Press ENTER when finished.

When the calibrator power is cycled, the limit setting is retained.

Note

To prevent pressure module damage, operation of the internal electric pump is automatically limited to the maximum rating of the module. For 1 inH₂O, 10 inH₂O and 1 psi modules, the internal pump is disabled.

Calibrating a P/I Transmitter

To calibrate a P/I (pressure to current) transmitter, apply a pressure to the transmitter and measure the transmitter's current loop output. Pressure can be applied with the Calibrator's internal pump or with an external pump.

⚠ Warning

To avoid a violent release of pressure or vacuum, always depressurize the system slowly using the pressure/vacuum release control before detaching any pressure line.

Using the Internal Pump

The internal pump can provide the rated pressure for the Calibrators.

The preferred use for the internal pump is shown in Figure 4, where the Calibrator displays pressure measured with the internal sensor and provided by the internal pump.

The internal pump can also be used with certain Fluke 700 Series Pressure Modules. In this case, pressure measured by the Pressure Module is displayed by the Calibrator. Appropriate pressure modules for each Calibrator model are identified in Table 5. Figure 5 shows the internal pump being used with a pressure module.

Note

If both a pressure module and the internal sensor are connected, the Calibrator displays ONLY the pressure module measurement.



To use the Calibrator's internal pump, refer to Figure 3 and perform the following steps:

1. Depressurize and drain the line before connecting the Calibrator.
2. Connect the pressure transmitter to the Calibrator internal sensor as shown in Figure 4 (for internal pressure sensor measurements) or Figure 5 (for pressure module measurements).

Note

To avoid leaks, use Teflon tape or similar sealant on all pressure connections.

3. Make sure the pressure/vacuum switch is in the desired position. Forward (clockwise) is for pressure; backward (counter-clockwise) is for vacuum.
4. Turn the pressure/vacuum release control backward (counter-clockwise) to vent pressure/vacuum from the pump.

5. Press  to zero the pressure display.
6. Turn the fine adjustment knob to mid-range.
7. Turn the pressure/vacuum release control forward (clockwise) to close the release valve.
8. Press  to apply pressure/vacuum.

Note

This knob adjusts a small internal reservoir to vary the total volume. With larger external pressure/vacuum volumes, this control will adjust pressure or vacuum within a smaller range.

9. Depressurize the system before disconnecting the pressure line.

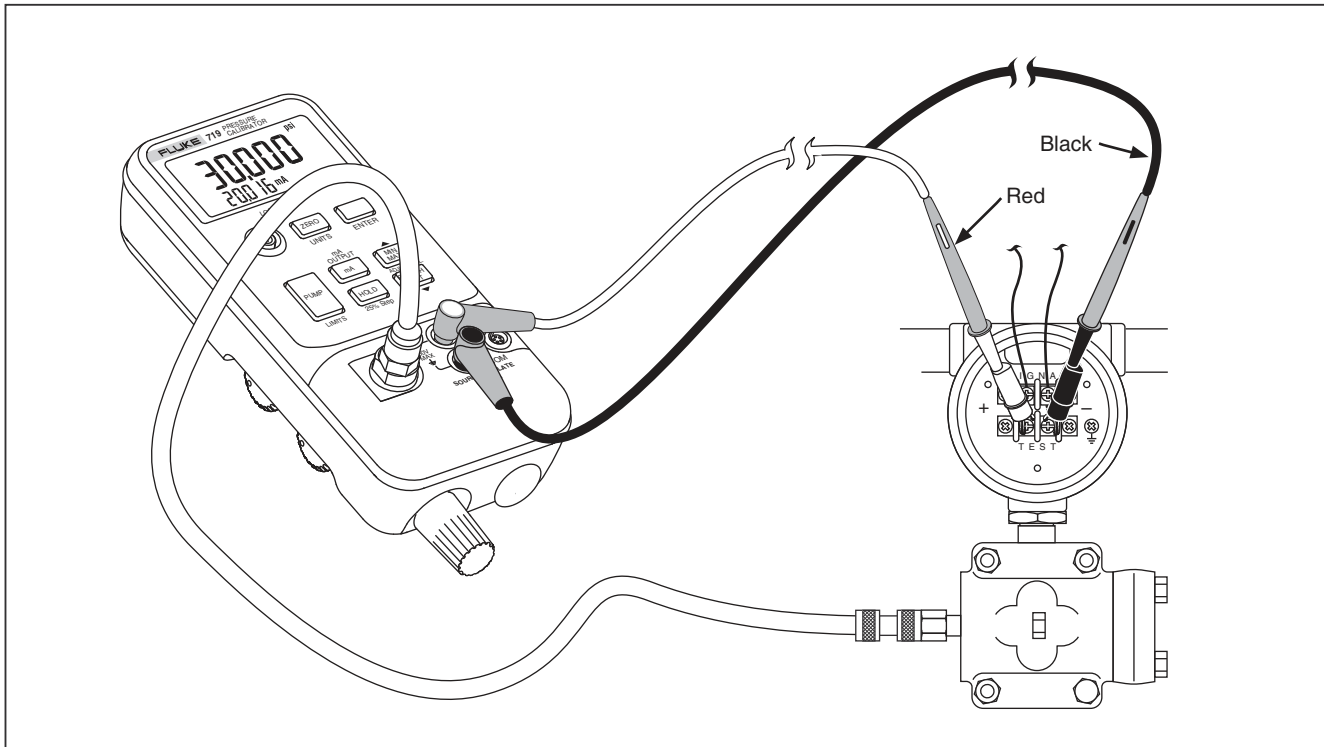

Figure 4. Internal Pressure Sensor with Internal Pump

fgx002f.eps

Pressure Calibrator with Electric Pump
Using the Internal Pump

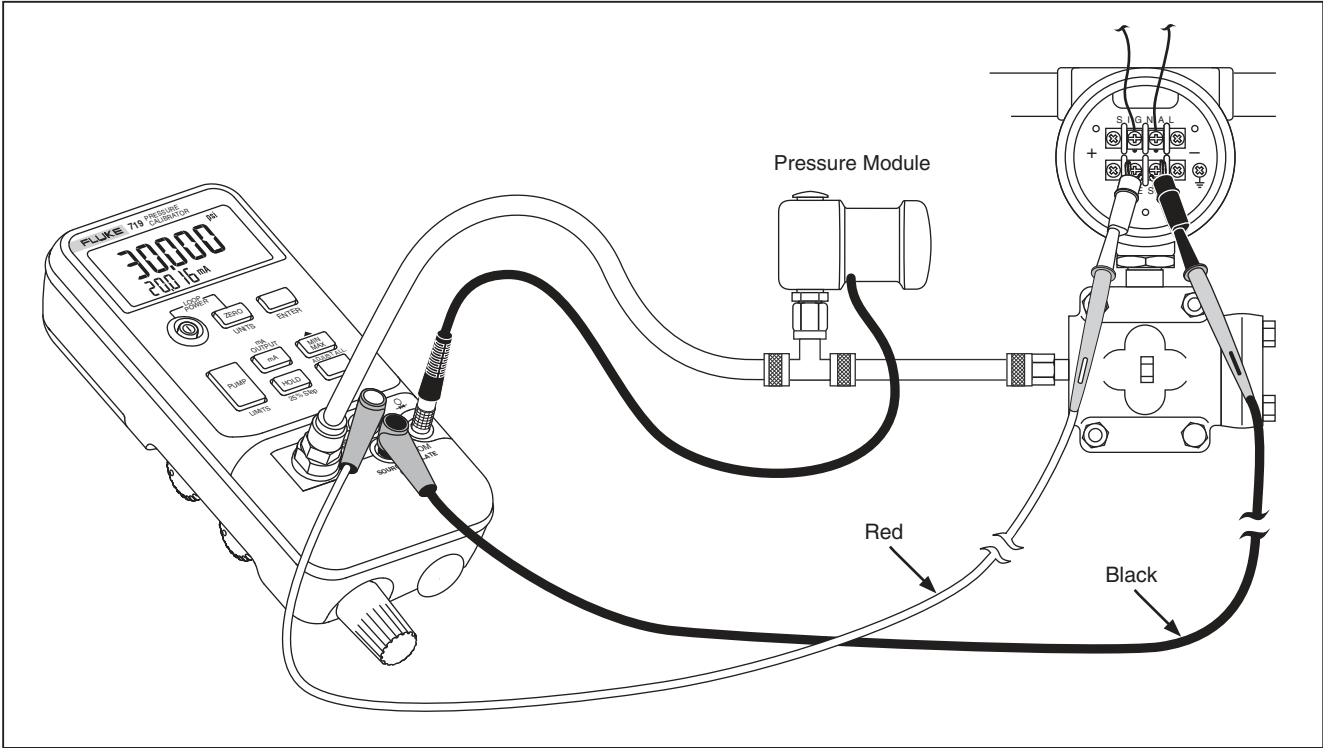

Figure 5. Pressure Module with Internal Pump

fgx010f.eps

Table 5. Recommended Pressure Modules

Pressure Module	External Pump	Internal Pump	
	719 30G/100G	719 30G	719 100G
700 P00	X		
700 P01	X		
700 P02	X	X	X
700 P22	X	X	X
700 P03	X	X	X
700 P23	X	X	X
700 P04	X	X	X
700 P24	X	X	X
700 P05	X	X	X
700 P06	X		X
700 P27	X		
700 P07	X		
700 P08	X		
700 P09	X		
700 PA3	X	X	X
700 PA4	X	X	X
700 PA5	X	X	X

Pressure Module	External Pump	Internal Pump	
	719 30G/100G	719 30G	719 100G
700 PA6	X		X
700 PV3	X	X	X
700 PV4	X	X	X
700 PD2	X	X	X
700 PD3	X	X	X
700 PD4	X	X	X
700 PD5	X	X	X
700 PD6	X		X
700 PD7	X		
700 P29	X		
700 P30	X		
700 P31	X		

Pump Valve Assembly Cleaning Instructions

1. Using a small screwdriver, remove the two valve retention caps located in the oval shaped opening on the underside of the Calibrator.
2. After the caps have been removed, gently remove the spring and o-ring assembly.
3. Set aside the valve assemblies in a safe area and clean out the valve body using a cotton swab soaked in IPA (isopropyl alcohol).
4. Repeat this process several times using a new cotton swab each time until there is no remaining sign of residue.
5. Run pump for a few seconds.
6. Clean the o-ring assembly and o-ring on the retention caps with IPA and inspect the o-rings closely for any cuts, nicks, or wear. Replace if needed.
7. Inspect the springs for wear or loss of tension. They should be approximately 8.6 mm long in the relaxed state. If they are shorter than this, they may not allow the o-ring to seat properly. Replace if needed.
8. Once all parts have been cleaned and inspected, reinstall the o-ring and spring assemblies into the valve body.

9. Reinstall the retention caps and gently tighten the cap.
10. Seal the output of the Calibrator and pump up the unit to at least 50 % its rated pressure.
11. Release the pressure and repeat several times to ensure that the o-rings seat properly.

The Calibrator is now ready for use.

Using an External Pump

⚠ Caution

To avoid damage to the Calibrator and possible release of pressure, do not connect the internal sensor to an external pressure source that exceeds the maximum rated pressure.

To develop higher pressure or vacuum, use an external pump (such as the Fluke Model 700PTP). Use a Fluke Pressure Module connected to the pressure module input on the Calibrator. Pressure modules are listed in Table 5. Make overall connections as shown in Figure 6.

Refer to setup and operating instructions included with the pressure module and pump.

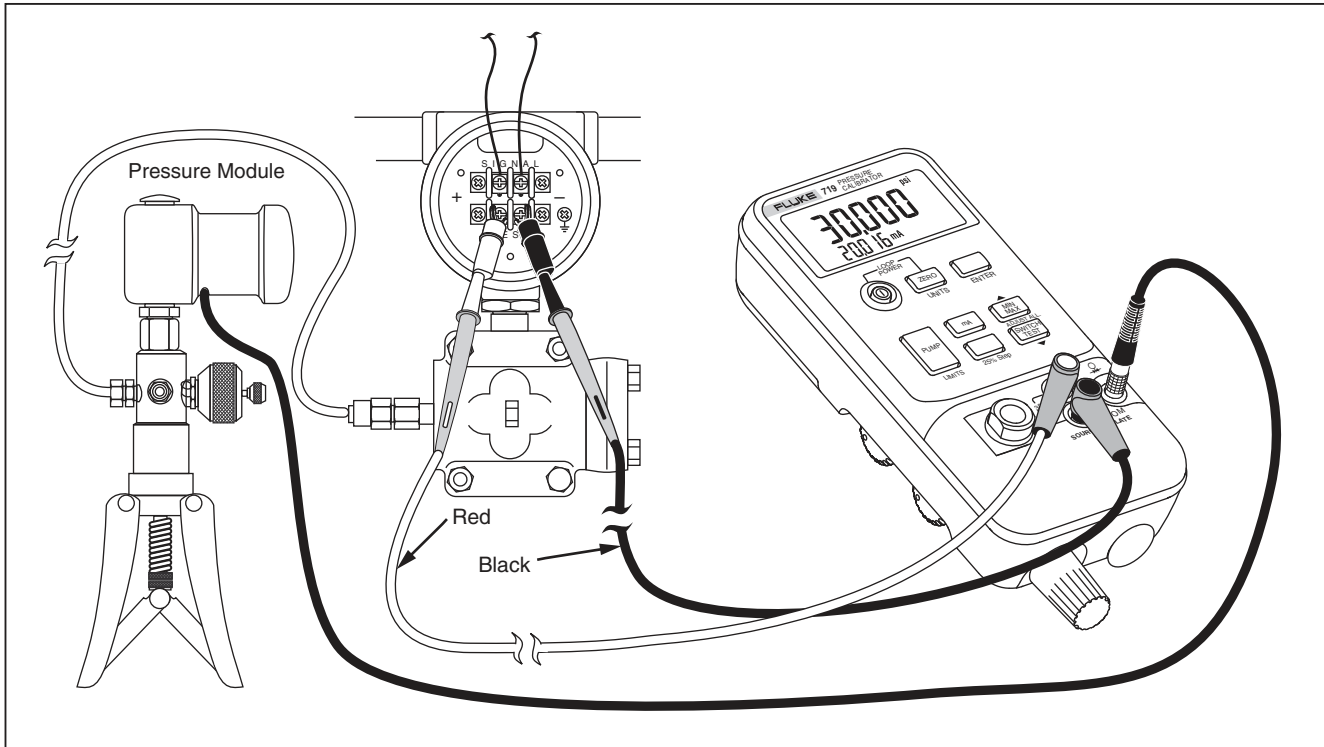

Figure 6. Pressure Module with External Pump

fgx006f.eps

External Fluke Pressure Module Compatibility

If inappropriate units are selected, the output of Fluke 700P Pressure Modules can cause the Calibrator display to overflow (**OL**), or displays values that are too low to be read. Refer to Table 6 for appropriate unit and range compatibility.

Table 6. Fluke Pressure Module Compatibility

Pressure Unit	Module Compatibility
psi	Available on all pressure ranges
inH ₂ O	All ranges through 3000 psi
cmH ₂ O	All ranges through 1000 psi
bar	15 psi and above
mbar	All ranges through 1000 psi
kPa	Available on all pressure ranges
inHg	Available on all pressure ranges
mmHg	All ranges through 1000 psi
kg/cm ²	15 psi and above

Supplying Loop Power

The Calibrator can supply loop power at 24 V dc to a current transmitter that is disconnected from the system. Use the following procedure:

1. With power off, hold down **ZERO** while pressing **☉**. **Loop Power** appears in the display.
2. With the transmitter disconnected from normal loop power, connect the Calibrator mA (+) and COM (-) test leads in series with the instrument current loop as shown in Figure 7.
3. Measure loop current in the mA display.
4. Press **☉** off to deactivate the 24 V dc supply when finished sourcing loop voltage.

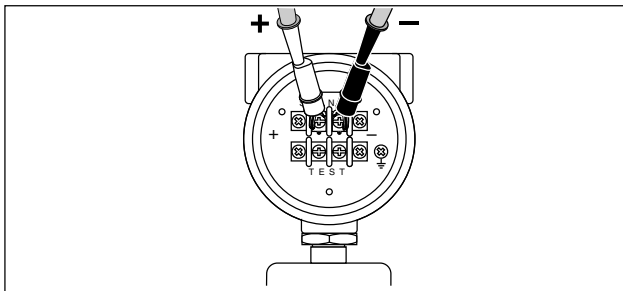

q0007f.eps

Figure 7. Sourcing Loop Voltage

mA Modes

Different mA functions can be accessed by repeatedly pressing **mA**:

- **mA-** measured current is displayed.
- **Percent Mode-** current is displayed as a percentage based on a 4-20 mA scale.
- **Percent Error Mode-** transmitter current output error is displayed. Error is calculated based on a configurable zero and span pressure and a 4-20 mA scale.
- **mA Source-** Outputs current displayed. Use **▼** or **▲** to adjust current setting.
- **mA Simulate-** Sets current when using an external 24 V loop power supply. Use **▼** or **▲** to adjust the current setting.

Note

Display flashes **OL** if there is an open circuit in source or simulate mode.

Sourcing 4 to 20 mA

To select current-sourcing mode, use the following procedure:

1. Press **[mA]** until **Source** is displayed.
2. Connect leads as shown in Figure 8.
3. Enter the desired current by pressing **▲** or **▼**.

Simulating a 4 to 20mA Transmitter

Simulate is a mode of operation in which the calibrator is connected into a loop in place of a transmitter and supplies a known, settable test current.

1. Connect the 24 V loop power source as shown in Figure 9.
2. Press **[mA]** until Simulate is displayed.
3. Enter the desired current by pressing **▲** or **▼**.

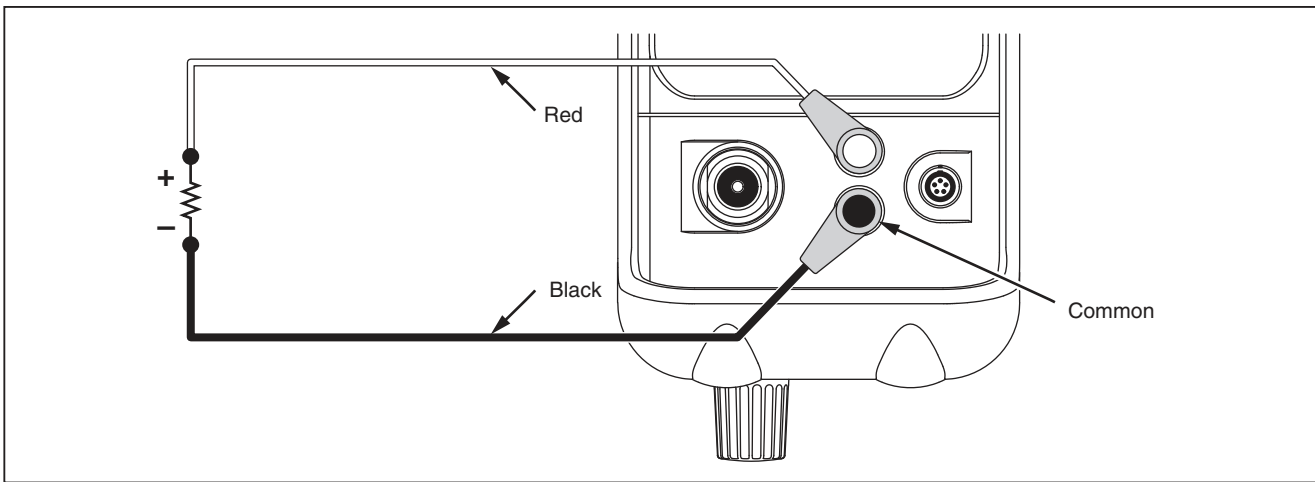
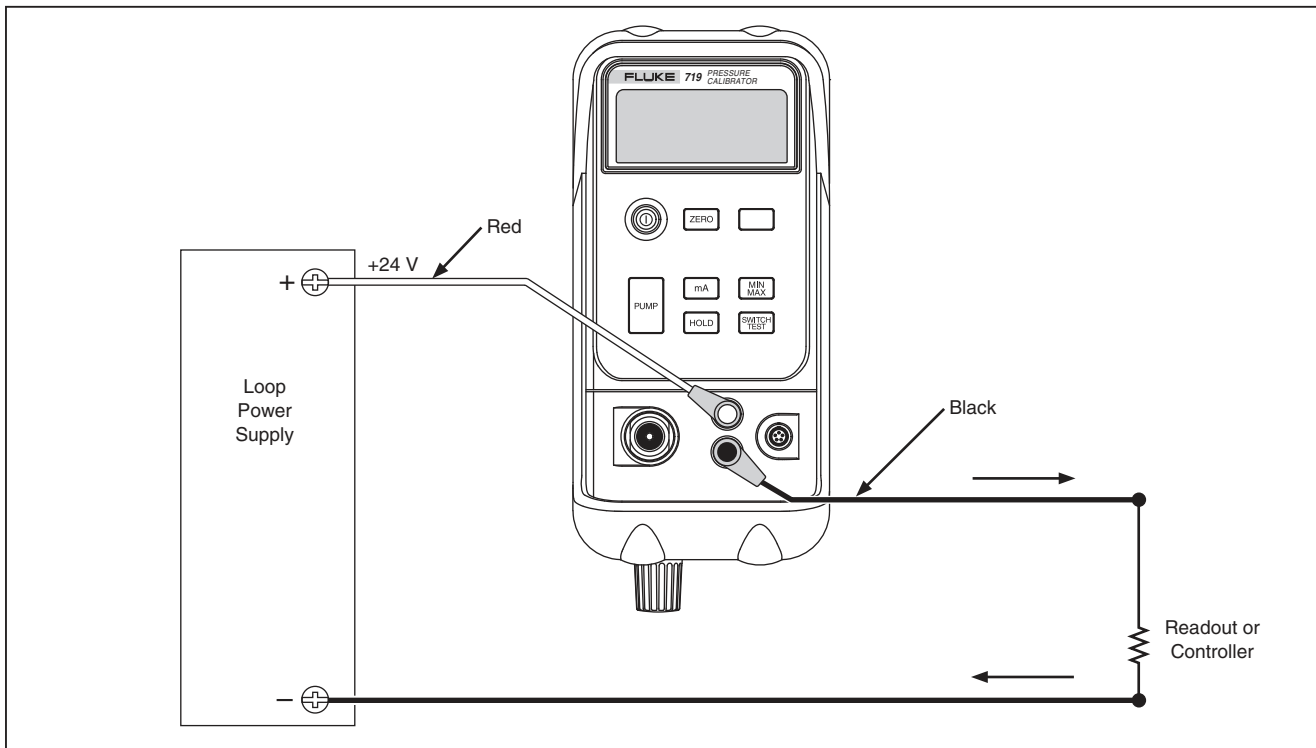

Figure 8. Sourcing mA Connections

fgx012.eps



fgx011.eps

Figure 9. Connections for Simulating a 4 to 20 mA Transmitter

Percent Error Setup

1. Press and hold **mA**. After 3 seconds the set icon and **0%** appears on the lower display.
2. Use **▼** and **▲** to adjust the % point for the Percent Error calculation, then press ENTER to confirm selection.
3. Press **MODE**. **100%** is displayed on the lower display.
4. Use **▼** and **▲** to adjust the 100% point for the Percent Error calculation.
5. Press ENTER to confirm the selection and to exit.

Maintenance

⚠ ⚠ Warning

To avoid possible electric shock, personal injury, or sudden release of pressure, review Safety Information before proceeding.

Remove test leads before opening.

For maintenance procedures not described in this manual, or if the Calibrator needs repair, contact a Fluke Service Center. See Contacting Fluke.

In Case of Difficulty

- Check the battery, test leads, pressure module, and pressure tubing. Follow replacement and connection instructions properly.
- Review this manual to make sure the Calibrator is used correctly.

Cleaning

⚠ Caution

To avoid damaging the Calibrator, do not use aromatic hydrocarbon or chlorinated solvents for cleaning. These solutions will react with and damage the plastics used in the Calibrator.

Periodically wipe the case with a damp cloth and detergent; do not use abrasives or solvents.

Replacing the Batteries

When the battery symbol (⊕) appears, replace the two 9 V alkaline batteries. Refer to Figure 10.

⚠ ⚠ Warning

To avoid false readings, which could lead to possible electric shock or personal injury, replace the batteries as soon as the battery indicator (⊕) appears. Remove test leads before changing the battery.

Calibration

Fluke recommends calibrating the Calibrator once a year to ensure that it performs according to its specifications.

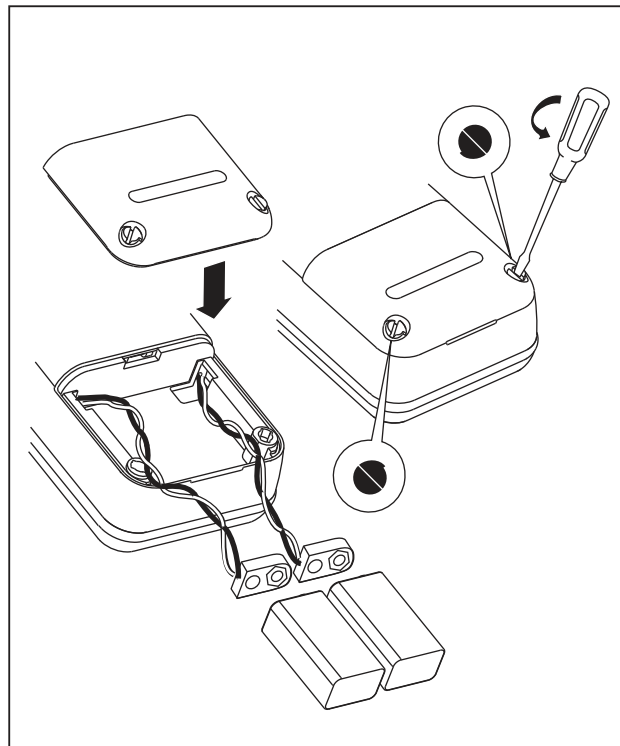

wh008f.eps

Figure 10. Battery Replacement

Parts and Accessories

Refer to Table 7 and Figure 11.

Table 7. Replacement Parts

Item	Description	Part/ Mod. No.	Qty
AC72	Alligator clip red	1670641	1
	Alligator clip black	1670652	1
BT1, BT2	9 V battery, ANSI/NEDA 1604A or IEC 6LR61	614487	2
Holster	Holster, Yellow	664182	1
H2, 3, 4	Case screw	832246	3
H5, 6	Battery door fasteners	948609	2
H7, 8	Bracket screw	641131	2
MP1	LCD bezel, 719 30G	3315359	1
MP1	LCD bezel, 719 100G	3322203	1
MP2	LCD, 719	3345775	1
MP3, 4	Pump retainer bracket kit, 719	3345782	2
MP5	Gasket	664208	1
MP6	Pump and vernier (no motor), 719	3345794	1
MP7, 8	Selector knob	3330278	2

719 Series
Users Manual

Item	Description	Part/ Mod. No.	Qty
MP9	Vernier adjust knob	664190	1
MP11, 12, 13	O-ring	146688	3
MP14	Spacer	687449	1
MP85	Case top/connector	3315431	1
MP86	Case bottom	3315686	1
MP89, 90	Non-skid foot	885884	2
MP92	Battery door	664177	1
S1	Keypad	3315673	1
TL20	Industrial test lead set	1639457	Opt
TL75	Test lead set	855742	1
TM1	<i>719 Product Overview Manual</i>	3316579	1
-	Electric motor, 719	3345802	1
CD-ROM	719 CD-ROM (contains Users Manual)	3316449	1
-	<i>71X Series Calibration Manual</i>	686540	Opt
-	Pump (with cleanout) rebuild kit, 719	3345816	Opt
-	719 30G Top Case Decal	2547000	1
-	719 100G Top Case Decal	2547017	1
-	Hose kit	3345825	Opt

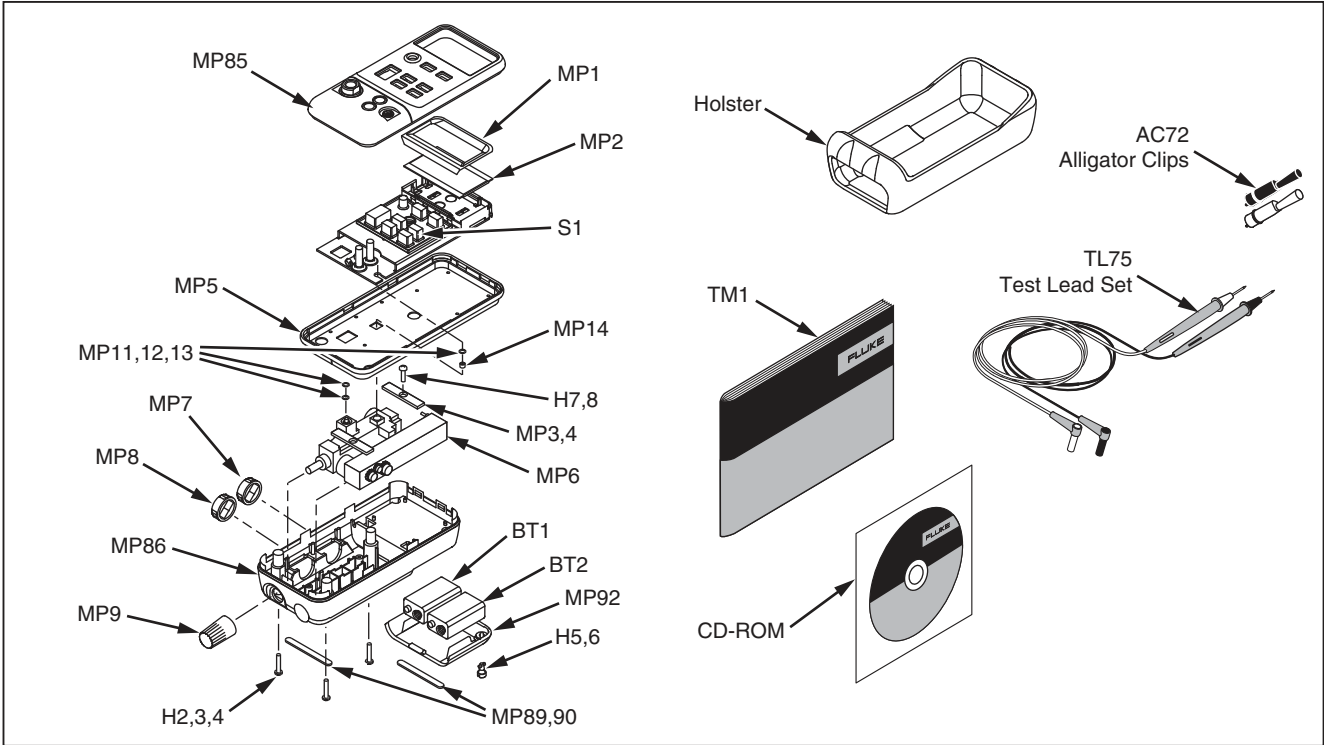

Figure 11. Replacement Parts

fgx004f.eps

Specifications

Specifications are based on a one year calibration cycle and apply for ambient temperature from +18 °C to +28 °C unless stated otherwise. Counts are the number of increments or decrements of the least significant digit.

Pressure Sensor Input

Model	Range	Accuracy	Max Non-destructive Pressure
30G	-12 to 36.0 psi	± 0.025 % of Range (6 month calibration)	60 psi
100G	-12 to 120.0 psi		200 psi
Temperature coefficient: 0.01 % of range per °C for temperature ranges -10 °C to 18 °C and 28 °C to 55 °C			

Pressure Module Input

Range	Resolution	Accuracy
(determined by Pressure Module)		

DC mA Measure and Source

Range	Resolution	Accuracy ±(% of Reading + Counts)
24 mA	0.001 mA	0.015 + 2
Maximum load on mA source is 1000 Ω. With HART resistor on, maximum load is 750 Ω. Fuseless overload protection Temperature coefficient: 0.005 % of range per °C for temperature ranges -10 °C to 18 °C and 28 °C to 55 °C		

Loop Supply

24 V dc nominal

Pressure Source

Model	Range
30G	-11 to 36.0 psi
100G	-11 to 120.0 psi

General Specifications

Maximum voltage applied between either mA terminal and earth ground or between the mA terminals: 30 V

Storage temperature: -30 °C to 60 °C

Operating temperature: -10 °C to 55 °C

Operating altitude: 3000 m maximum

Relative humidity: 95 % up to 30 °C, 75 % up to 40 °C, 45 % up to 50 °C, and 35 % up to 55 °C

Vibration: Random 2 g, 5 Hz to 500 Hz per MIL-PRF-28800F Class 2

Shock: 1 m drop test, per IEC 61010-1

Protection Class: Pollution Degree II

Safety:

- Complies with EN/IEC61010-1 2nd ed.
- **Agency Approvals:** CSA-C22.2 No. 61010-1-04

Power requirements: Two 9 V batteries (ANSI/NEDA 1604A or IEC 6LR61)

Size: 60 mm H x 87 mm W x 210 mm L (2.38 in H x 3.41 in W x 8.28 in L); with holster: 66 mm H x 94 mm W x 216 mm L (2.61 in H x 3.72 in W x 8.5 in L)

Weight with Holster: 912 g (2.00 lb)

Calibration Cycle: 6 months to 2 years based on desired accuracy.

Contacting Fluke

To contact Fluke for product information, operating assistance, service, or to get the location of the nearest Fluke distributor or service center, call:

1-888-44-FLUKE (1-888-443-5853) in U.S.A
1-800-36-FLUKE in Canada
+31-402-675-200 in Europe
+81-3-3434-0181 Japan
+65-738-5655 Singapore
+1-425-446-5500 from other countries

Or visit Fluke's website at: www.fluke.com.

Register the Calibrator at: <http://register.fluke.com>.

Address correspondence to:

Fluke Corporation
P.O. Box 9090,
Everett, WA 98206-9090
U.S.A.

Fluke Europe B.V.
P.O. Box 1186,
5602 BD Eindhoven

