

# 323/324/325 Clamp Meters Quick Reference Guide

## ⚠ Warning

To prevent possible electrical shock, fire, or personal injury, read the "323/324/325 Safety Sheet" before you use this Product.

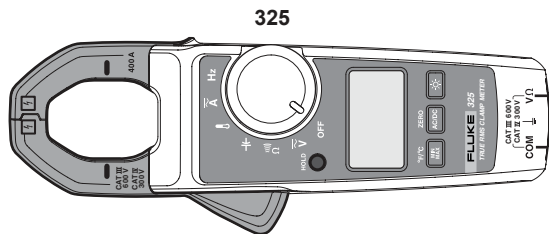

325

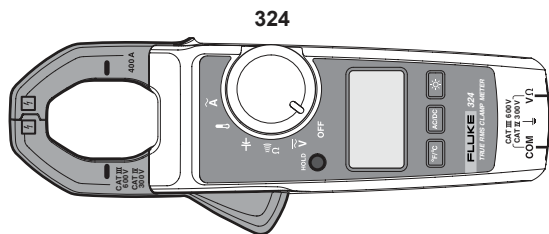

324

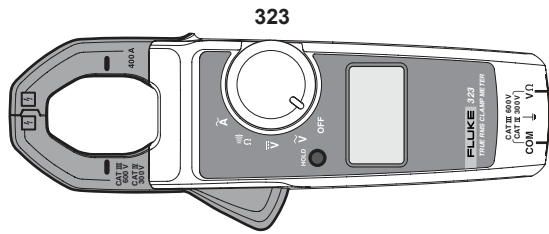

323

OFF

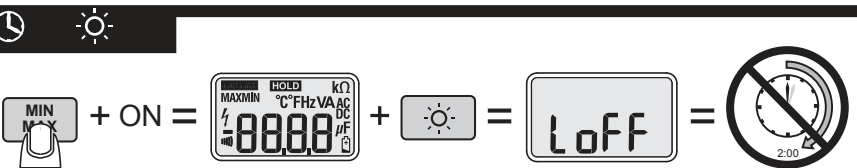
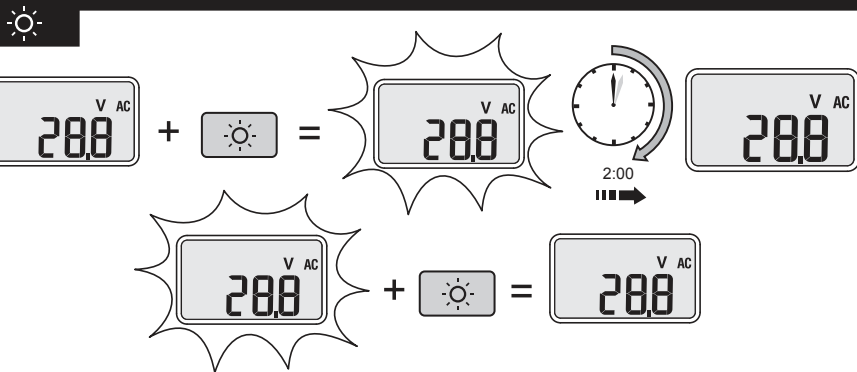
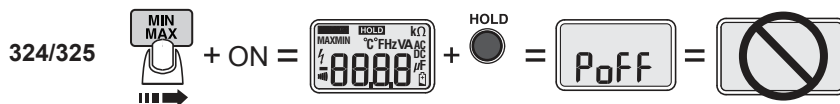
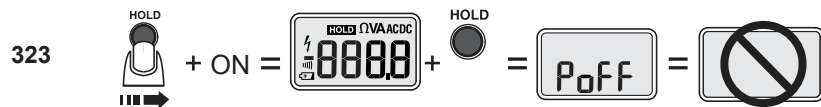
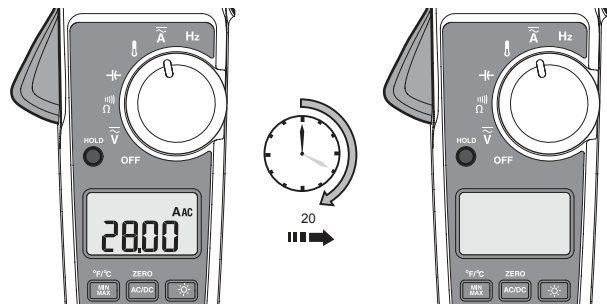

A

$\tilde{A}$  323, 324  
 $\bar{A}$  325

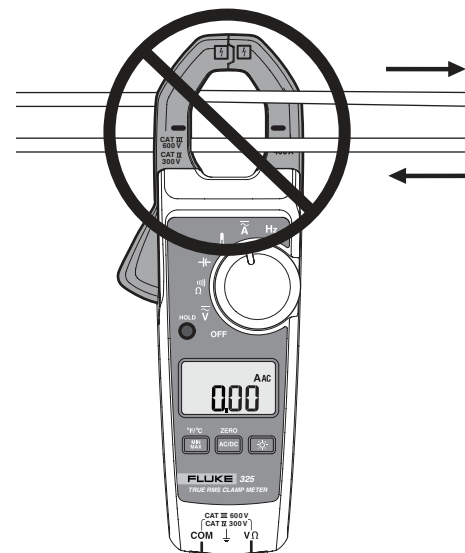
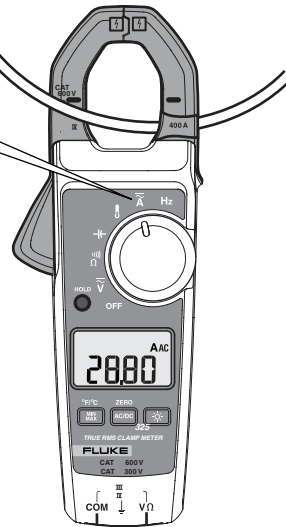

$\tilde{V}$   $\bar{V}$   $\Omega$

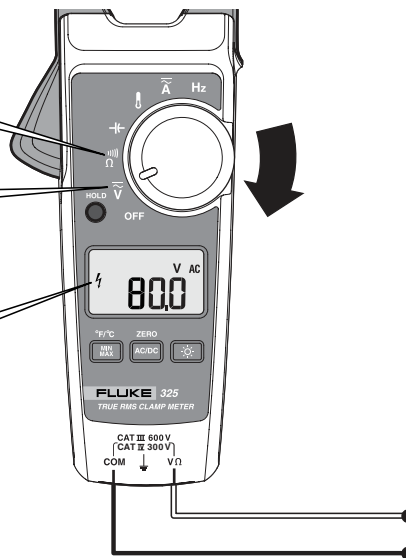
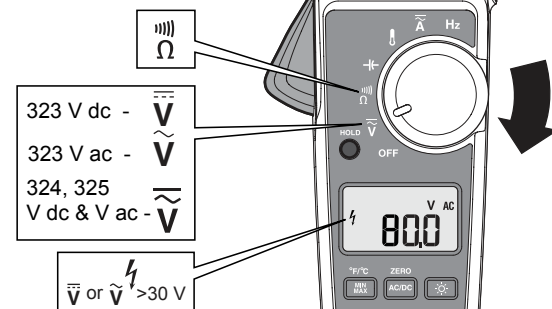

$\Omega$

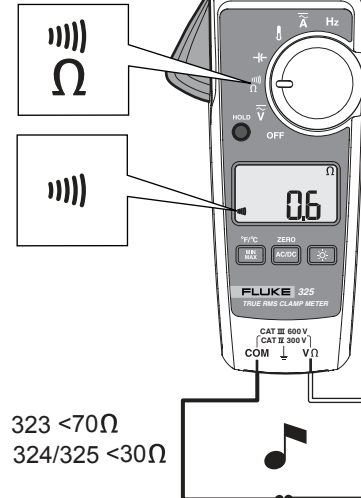

323 < 70  $\Omega$   
324/325 < 30  $\Omega$

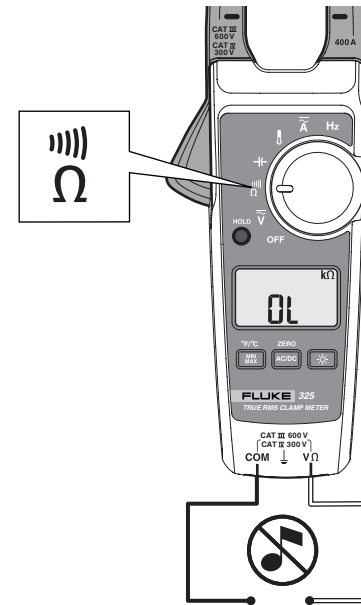

HOLD

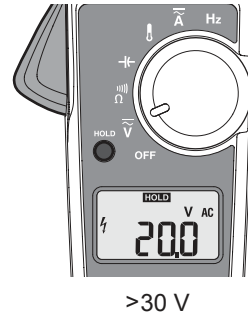
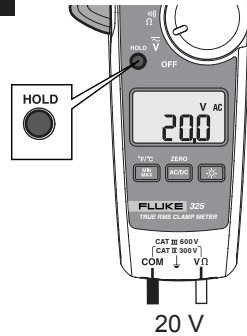

AC/DC & ZERO

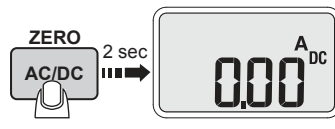
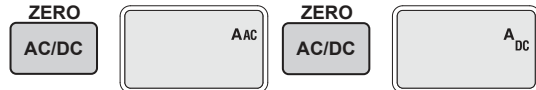

324, 325

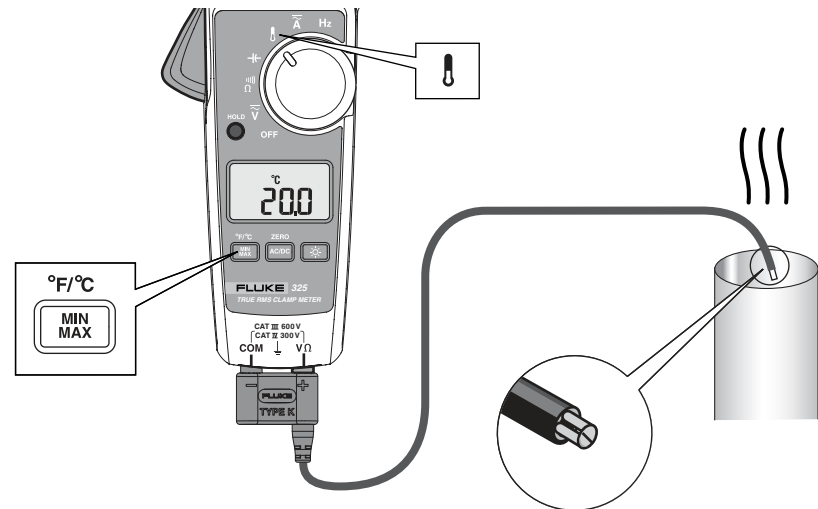

324, 325

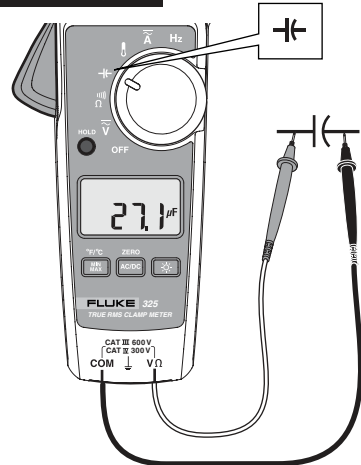

Hz 325

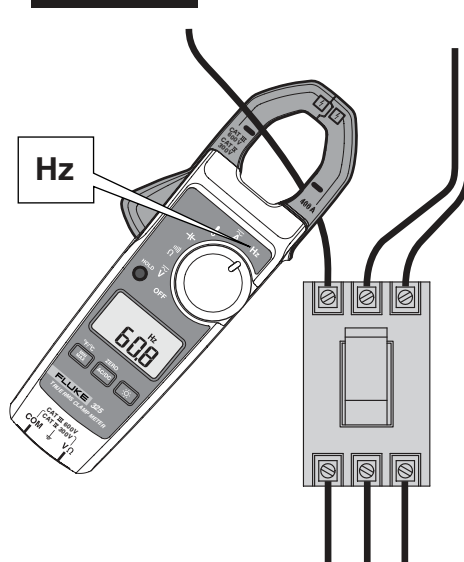

Specifications

Electrical Specifications

**AC Current (Jaw)**

Range	323	.....	400.0 A
	324, 325	.....	(40.00, 400.0) A
Resolution	323	.....	0.1 A
	324, 325	.....	(0.01, 0.1) A
Accuracy	323, 325	.....	2.0 % ±5 digits (45 – 65 Hz)
		.....	2.5 % ±5 digits (65 – 400 Hz)
	324	.....	1.5 % ±5 digits (45 – 400 Hz)

Note: Add 2 % for position sensitivity.

DC Current with Jaw (325)

Range	.....	(40.00, 400.0) A
Resolution	.....	(0.01, 0.1) A
Accuracy	.....	2.0 % ± 5 digits

AC Voltage

Range	.....	600.0 V
Resolution	.....	0.1 V
Accuracy (45 – 400 Hz)	.....	1.5 % ± 5 digits

DC Voltage

Range	.....	600.0 V
Resolution	.....	0.1 V
Accuracy	.....	1 % ±5 digits

Resistance

Range	323, 324	.....	(400.0, 4000) Ω
	325	.....	(400.0, 4000, 40000) Ω
Resolution	.....	(0.1, 1, 10) Ω	
Accuracy	.....	1 % ±5 digits	
Continuity Beeper			
	323	.....	≤70 Ω
	324/325	.....	≤30 Ω

Capacitance (324, 325)

Range	.....	(100.0, 1000) μF
Resolution	.....	(0.1, 1) μF
Accuracy	.....	1 % ±4 digits

Frequency with Jaw (325)

Range	.....	5.0 to 500.0 Hz
Resolution	.....	0.1 Hz
Accuracy	.....	0.5 % ±4 digits
Trigger Level	.....	5 to 10 Hz, ≥10 A
	.....	10 to 100 Hz, ≥5 A
	.....	100 to 500 Hz, ≥10 A

Contact Temperature (324, 325)

Range	.....	-10.0 °C to 400.0 °C
Resolution	.....	0.1 °C
Accuracy	.....	1 % ±8 digits

Note: Temperature uncertainty (accuracy) does not include error of the thermocouple probe.

Mechanical Specifications

Size (L x W x H)	.....	(207 x 75 x 34) mm	
Weight			
	323	.....	265 g
	324	.....	208 g
	325	.....	283 g

Environmental Specifications

Operating Temperature	.....	-10 °C to +50 °C
Storage Temp	.....	-30 °C to +60 °C
Operating Humidity	.....	Non Condensing (≤10 °C)
		≤90 % RH (at 10 °C to 30 °C)
		≤75 % RH (at 30 °C to 40 °C)
		≤45 % RH (at 40 °C to 50 °C)
		(Without Condensation)

Operating Altitude	.....	2000 meters
Storage Altitude	.....	12,000 meters

EMI, EMC  
Electromagnetic

Compatibility ..... Applies to use in Korea only. Class A Equipment (Industrial Broadcasting & Communication Equipment) [1]

[1] This product meets requirements for industrial (Class A) electromagnetic wave equipment and the seller or user should take notice of it. This equipment is intended for use in business environments and is not to be used in homes.

Temperature Coefficients ..... Add 0.1 x specified accuracy for each degree C above 28 °C or below 18 °C

Over Voltage Category ..... CAT IV 300 V, CAT III 600 V

Safety Compliance ..... EN/IEC 61010-1, Pollution Degree 2  
EN/IEC 61010-2-032  
EN/IEC 61010-031:2002/A1:2008  
CE

Agency Approvals ..... Complies with CAN/CSA-C22.2 No. 61010-1, 2nd edition, including Amendment 1.,

IP Rating ..... IP 30 Per IEC 60529:2001; Non-operating

Batteries ..... 2 AAA, NEDA 24A, IEC LR03

+

